



XTX 820
Computer On Module
Reference Manual

P/N 5001796A Revision B

Notice Page

NOTICE

No part of this document may be reproduced, transmitted, transcribed, stored in a retrieval system, or translated into any language or computer language, in any form or by any means, electronic, mechanical, magnetic, optical, chemical, manual, or otherwise, without the prior written permission of Ampro Computers, Incorporated.

DISCLAIMER

Ampro Computers, Incorporated makes no representations or warranties with respect to the contents of this manual or of the associated Ampro products, and specifically disclaims any implied warranties of merchantability or fitness for any particular purpose. Ampro shall under no circumstances be liable for incidental or consequential damages or related expenses resulting from the use of this product, even if it has been notified of the possibility of such damages. Ampro reserves the right to revise this publication from time to time without obligation to notify any person of such revisions. If errors are found, please contact Ampro at the address listed below on the Notice page of this document.

TRADEMARKS

Ampro and the Ampro logo are registered trademarks, and CoreModule, EnCore, Little Board, LittleBoard, MightyBoard, MiniModule, ReadyBoard, ReadyBox, ReadyPanel, and ReadySystem are trademarks of Ampro Computers, Inc. All other marks are the property of their respective companies.

REVISION HISTORY

Revision	Reason for Change	Date
A, A	Initial Release	Mar/06
A, B	BIOS Update/Changes	Sept/06

Ampro Computers, Incorporated
5215 Hellyer Avenue
San Jose, CA 95138-1007
Tel. 408 360-0200
Fax 408 360-0222
www.ampro.com

© Copyright 2006, Ampro Computers, Incorporated

Audience Assumptions

This reference manual is for the person who designs computer related equipment, including but not limited to hardware and software design and implementation of the same. Ampro Computers, Inc. assumes you are qualified in designing and implementing your hardware designs and its related software into your prototype computer equipment.

Contents

Chapter 1 About This Manual	1
Purpose of this Manual	1
Reference Material	1
Related Ampro Products	2
Chapter 2 Product Overview	5
ETX [®] Concept and XTX [™] Extension	5
Product Description	6
Board Features	7
Block Diagram	10
Major Integrated Circuits (ICs)	11
Connector Definitions	12
Specifications	13
Physical Specifications	13
Mechanical Specifications	13
Power Specifications	14
Environmental Specifications	14
Thermal/Cooling Solutions	14
Chapter 3 Hardware	15
Overview	15
CPU (U1)	16
Celeron M Processor	16
Pentium M Processors	16
Memory	16
DDR2 SODIMM Socket (J5)	16
Flash Memory (U17)	16
Interrupt Channel Assignments (IRQs)	16
Memory Map	17
I/O Address Map	18
PCI Bus Interface Connector (J1)	19
PCI Bus	19
Universal Serial Bus (USB)	24
Serial Interrupt Request	24
AC'97 Sound	24
PCI Express Interface (J2)	29
PCI Express/ExpressCards	29
Serial ATA	30
Additional Universal Serial Bus (USB) Ports	30
AC'97/HDA CODEC	31
LPC Interface	31
Extended System Management	31
Primary I/O Interface (J3)	35
Floppy Port	35
Parallel Port	36
Serial Ports 1 and 2	37
Infrared (IrDA) Port	38
PS/2 Keyboard	38

Contents

PS/2 Mouse	38
Video Interface	39
CRT Interface	39
LVDS Interface	40
TV Out (Component and S-Video)	42
IDE and Auxiliary Interface (J4)	46
IDE Ports	46
Ethernet Port Interface	48
Power Control Signals	49
Power Management Signals	49
Speaker	49
Real Time Clock (RTC)/Battery	50
SMBus (I ² C Bus).....	50
Miscellaneous	55
SDVO Port.....	55
Serial Console (Remote Access)	56
Temperature Monitoring	56
Watchdog Timer (WDT).....	57
Power Input.....	58
Power and Sleep States	58
Power-On Switch.....	58
Sleep States (ACPI)	59
Wake Up Activities.....	60
Chapter 4 BIOS Setup Utility.....	61
Introduction	61
Accessing BIOS Setup Utility (VGA Display)	61
Accessing BIOS Setup Utility (Remote Access)	62
BIOS Menus.....	63
BIOS Main Setup Screen	63
BIOS Advanced Setup Screen	64
BIOS Boot Setup Screen.....	81
BIOS Security Setup Screen	84
BIOS Power Setup Screen.....	86
BIOS Exit Setup Screen	88
Appendix A Technical Support.....	91
Appendix B LAN Boot Feature.....	93
Introduction	93
Accessing the LAN (PXE) Boot Feature	94
Alternate Method of Selecting LAN Boot.....	95
Appendix C Connector Part Numbers.....	97
Index	99

List of Figures

Figure 2-1. XTX 820 and Custom Baseboard	5
Figure 2-2. Typical Design Flow	6
Figure 2-3. Functional Block Diagram	10
Figure 2-4. XTX 820 (Top view).....	11
Figure 2-5. Connector Locations (Bottom view)	12

Figure 2-6. XTX 820 Dimensions (Top, Through Board View)	13
Figure 4-1. BIOS Main Setup Screen.....	63
Figure 4-2. BIOS Advanced Setup Screen	64
Figure 4-3. BIOS Boot Setup Screen	81
Figure 4-4. BIOS Security Setup Screen	84
Figure 4-5. BIOS Power Setup Screen	86
Figure 4-6. BIOS Exit Setup Screen	88

List of Tables

Table 2-1. Major Integrated Circuit Description and Function	11
Table 2-2. Board Connector Descriptions	12
Table 2-3. Weight and Footprint Dimensions.....	13
Table 2-4. Power Supply Requirements	14
Table 2-5. Environmental Requirements	14
Table 3-1. Interrupt Channel Assignments (IRQs).....	17
Table 3-2. Memory Map	17
Table 3-3. I/O Address Map	18
Table 3-4. Simplified PCI Pin/Signal Descriptions (J1).....	19
Table 3-5. Simplified USB Interface Pin/Signal Descriptions (J1)	24
Table 3-6. Simplified Serial Interrupt Request (J1)	24
Table 3-7. Simplified Audio Interface Pin/Signal Descriptions (J1).....	25
Table 3-8. Complete J1 Interface Pin/Signal Descriptions (J1)	25
Table 3-9. PCI Express Interface Pin/Signal Descriptions (J2)	29
Table 3-10. Serial ATA Interface Pin/Signal Descriptions (J2)	30
Table 3-11. USB 4 & 5 Interface Pin/Signal Descriptions (J2).....	30
Table 3-12. Audio CODEC Interface Pin/Signal Descriptions (J2)	31
Table 3-13. LPC Interface Pin/Signal Descriptions (J2).....	31
Table 3-14. Miscellaneous Interface Pin/Signal Descriptions (J2).....	32
Table 3-15. Complete J2 Interface Pin/Signal Descriptions (J2)	32
Table 3-16. Simplified Floppy Drive Interface Pin/Signal Descriptions (J3).....	35
Table 3-17. Simplified Parallel Interface (SPP) Pin/Signal Descriptions (J3)	36
Table 3-18. Simplified Serial Interface Pin/Signal Descriptions (J3).....	37
Table 3-19. Simplified Keyboard, Mouse, and Infrared (IrDA) Port Pin/Signal Descriptions (J3)...	39
Table 3-20. Simplified CRT Interface Pin/Signal Descriptions (J3)	40
Table 3-21. Simplified LVDS Interface Pin/Signal Descriptions (J3)	41
Table 3-22. Simplified TV Out (S-Video) Interface Pin/Signal Descriptions (J3)	42
Table 3-23. Complete J3 Interface Pin/Signal Descriptions (J3)	42
Table 3-24. Simplified Primary IDE Interface Pin/Signal Descriptions (J4)	46
Table 3-25. Simplified Ethernet Port Pin/Signal Descriptions (J4).....	48
Table 3-26. Simplified Power Control and Miscellaneous Pin/Signal Descriptions (J4)	50
Table 3-27. SMBus Reserved Addresses	51
Table 3-28. Complete J4 Interface Pin/Signal Descriptions (J4)	51
Table 3-29. SDVO Interface Pin/Signal Descriptions (J6)	55
Table 3-30. Typical ATX Power Interface Pin/Signal Descriptions	58
Table 3-31. Wake Up Activities and Conditions	60
Table 4-1. BIOS Setup Utility Menus	62
Table 4-2. Exiting and Loading Default Keys.....	63
Table 4-3. Local Flat Panel Type List.....	66

Contents

Table A-1. Technical Support Contact Information.....91
Table C-1. Connector and Manufacture's Part Numbers97

Purpose of this Manual

This manual is for designers of systems based on the XTX 820 Computer on Module (COM). This manual contains information that permits designers to create an embedded system based on specific design requirements.

Information provided in this reference manual includes:

- XTX 820 Specifications
- Environmental requirements
- Major integrated circuits (chips) and features implemented
- All connectors with pin numbers and definitions
- BIOS Setup Utility information

Information not provided in this reference manual includes:

- Detailed chip specifications
- Internal component operation
- Internal registers or signal operations
- Bus or signal timing for industry standard busses and signals

Reference Material

The following list of reference materials may be helpful for you to complete your design successfully. Most of this reference material is also available on the Ampro web site in the Embedded Design Resource Center. The Embedded Design Resource Center was created for embedded system developers to share Ampro's knowledge, insight, and expertise gained from years of experience.

Specifications

- ETX Component SBC™ Specification Revision 2.7, 2001
- ETX Component SBC™ Design Guide, Revision 1.5, 2001

For latest revision of the ETX specifications, contact the Working Group, at:

Web site: <http://www.etx-ig.org>

- XTX Interface Specification, Revision 1.0, July 13, 2005
- XTX Design Guide, Revision 1.0, February 22, 2006

For latest revision of the XTX specifications or design guide, contact the XTX Consortium, at:

Web site: <http://www.xtx-standard.org>

- PCI 2.1 Compliant Specifications

For latest revision of the PCI specifications, contact the PCI Special Interest Group Office at:

Web site: <http://www.pcisig.com>

Major Integrated Circuit (ICs or Chips) Specifications used on the XTX 820 COM:

- Intel Corporation and the Pentium® M 745, Pentium® M 738, or Celeron® M 373 processors
Web site: <http://www.intel.com/design/mobile/datashts/302189.htm> = Pentium M
Web site: <http://www.intel.com/design/mobile/datashts/303110.htm> = Celeron M
- Intel Corporation and the 82915GM and 82801FBM chips used for the Memory Hub/Video controller and I/O Hub respectively.
Web site: <http://www.intel.com/design/mobile/datashts/305264.htm> = Memory Hub
Web site: <http://www.intel.com/design/chipsets/specupdt/301474.htm> = I/O Hub
- Winbond Electronics, Corp. and the W83627HG chip used for the Super I/O controller
Web site: http://www.winbond-usa.com/products/winbond_products/pdfs/PCIC/W83627HF_F_HG_Ga.pdf
- Intel Corporation and the U82562GZ chip used for the Physical Ethernet controller
Web site: http://www.intel.com/design/network/products/lan/docs/82562_docs.htm
- Realtek Semiconductor, Corp's chip ALC655, used for the AC'97 Audio CODEC.
Web site: ftp://202.65.194.18/pc/ac97/alc655/ALC655_DataSheet_1.3.pdf

NOTE

If you are unable to locate the datasheets using the links provided, go to the manufacturer's web site where you can perform a search using the chip datasheet number or name listed, including the extension, (htm for web page, pdf for files name, etc).

Related Ampro Products

The following items are directly related to successfully using the Ampro product you have just purchased or plan to purchase. Ampro highly recommends that you purchase and utilize a XTX 820 QuickStart Kit or Development System.

XTX 820 Support Products

- XTX 820 QuickStart Kit (QSK)
The QuickStart Kit includes the XTX 820 module, RAM, a baseboard, and the XTX 820 Documentation and Software (Doc & SW) CD-ROM.
- XTX 820 Documentation and Software CD-ROM
The XTX 820 Documentation and Software (XTX 820 Doc & SW) CD-ROM is provided with the XTX 820. The CD-ROM includes all of the XTX 820 documentation, including this reference manual and the XTX 820 QuickStart Guide in PDF format, software utilities, board support packages, and drivers for the unique devices used with Ampro supported operating systems.

Ampro XTX Products

- XTX 800 – This high-performance, compact, rugged Computer-On-Module (COM) solution uses Intel 1.8 GHz Pentium M 745, 1.4 GHz Pentium M 738, or 1.0 GHz Celeron M 373 with an Intel 852GM chipset. This XTX module comes standard with enhanced peripherals, including PCI bus, two Serial ATA ports and one Ultra/DMA 33/66/100 EIDE controller for two EIDE drives, six USB 2.0 ports, one shared EPP/ECP parallel/ floppy port, two serial ports with TTL levels, one Infrared (IrDA) port, PS/2 keyboard and mouse interfaces, and an AC'97/HDA (High Definition Audio) CODEC on the module. The XTX 800 also supports ACPI 2.0 Power Management, 10/100BaseT Ethernet interface, up to 1 GB of DDR RAM in a single 200-pin SODIMM slot, a 128-bit graphics controller for CRTs and LVDS flat panels, and a SDVO (Serial Digital Video Output) interface.

Ampro ETX Products

- ETX 700 – This high-performance, compact, rugged Computer-On-Module (COM) solution uses Intel® 650 MHz Low Voltage Celeron® or 400 MHz Ultra Low Voltage Celeron CPUs with up to 512 kB Level 2 Cache on board. This ETX module comes with the standard peripherals, including dual Ultra/DMA 33/66/100 IDE, floppy drive interface, PCI bus, ISA bus, serial, parallel, PS/2 keyboard and mouse interfaces, 10/100BaseT Ethernet, USB ports, AGP 4X equivalent video interface with up to 32 MB UMA Frame Buffer that supports built-in LVDS at 1600x1200 resolution, and AC'97 audio. It also supports up to 512 MB of SODIMM DRAM on a 50% thicker PCB to meet your custom baseboard needs.
- ETX 802 – This high-performance, compact, rugged Computer-On-Module (COM) solution uses Intel 1.4 GHz LV Pentium® M 738, 1.0 GHz Celeron M 373, or 800 MHz ULV Celeron M CPUs with an Intel 852GME chipset. This ETX module comes with the standard peripherals, including dual Ultra/DMA 33/66/100 IDE, floppy drive interface, PCI bus, ISA bus, serial, parallel, PS/2 keyboard and mouse interfaces, 10/100BaseT Ethernet, USB 2.0 ports, 128-bit graphics controller interface with up to 64 MB UMA Frame Buffer that supports CRT and LVDS at 1600x1200 resolution, and AC'97 audio. It also supports up to 1 GB of SODIMM DDR RAM on a 50% thicker PCB to meet your custom baseboard needs.

Other Ampro Products

- CoreModule™ Family – These complete embedded-PC subsystems on single PC/104 or PC/104-Plus form-factor (3.6"x3.8") modules feature 486, Celeron, or Celeron M CPUs. Each CoreModule includes a full complement of PC core logic functions, plus disk controllers, and serial and parallel ports. Most modules also include CRT and flat panel graphics controllers and/or an Ethernet interface. The CoreModules also come with built-in extras to meet the critical reliability requirements of embedded applications. These include onboard solid state disk compatibility, watchdog timer, and smart power monitor.
- LittleBoard™ Family – These high-performance, highly integrated single-board computers use the EBX form factor (5.75"x8.00"), and are available with the Intel Pentium M, Celeron M, Pentium III, or Celeron processors. The EBX-compliant LittleBoard single-board computers offer functions equivalent to a complete laptop or desktop PC system, plus several expansion cards. Built-in extras to meet the critical requirements of embedded applications include onboard solid state disk capability, watchdog timer, and smart power monitor.
- MightyBoard™ Family – These low-cost, high-performance single-board computers (SBC) use the Mini-ITX form factor (6.75"x 6.75") and are available with Intel Celeron M or Pentium M processors. MightyBoard products offer the equivalent functions of a complete laptop or desktop PC system, including DDR memory, high performance graphics, USB 2.0, Gigabit Ethernet, plus standard PCI expansion capability in one card slot.

- MiniModule™ Family – This line of peripheral interface modules compliant with PC/104,PC/104-Plus, and/or PCI-104 form factor (3.6"x3.8") standards can be used with Ampro's CoreModule, LittleBoard, and ReadyBoard single-board computers (SBCs) to expand the I/O configuration of embedded systems. Ampro's highly reliable MiniModule products add value to existing designs by adding I/O ports, such as IEEE 1394 (Firewire), or by adding support for legacy boards, such as a PCI-to-ISA bridge adapter board.
- ReadyBoard™ Family – These low-cost, high-performance single-board computers (SBC) use the EPIC form factor (4.5"x6.5") and are available with the Intel Pentium M, Celeron M, and Celeron processors. ReadyBoard products offer functions equivalent to a complete laptop or desktop PC system with standard PC-style connections, and features such as DDR or DDR2 memory, high performance graphics, USB 2.0, Ethernet and Gigabit Ethernet ports, AC'97 Audio, plus several expansion cards. Ampro also includes such features as watchdog timer, battery-free boot, a customizable splash screen, Oops! jumper (BIOS recovery), and serial console

This introduction presents general information about the XTX Architecture and the XTX 820 Computer-On-Module (COM). After reading this chapter you should understand:

- XTX Computer-On-Module concept
- XTX 820 architecture and features
- Major components
- Connectors
- Specifications

ETX[®] Concept and XTX[™] Extension

The Embedded Technology eXtended (ETX) module concept is an off the shelf, multi vendor, single-board-computer that integrates all the core components of a common PC and is mounted onto an application specific baseboard. ETX modules have a standardized form factor of just 95 mm x 114 mm and use an identical pin compatible connector on the four system connectors. The ETX module provides most of the PC functional requirements for any application. These functions include, but are not limited to, graphics, sound, keyboard/mouse, IDE, Ethernet, parallel, serial and USB ports. Four ruggedized connectors provide the baseboard interface and carry all the I/O signals to and from the ETX module.

Baseboard designers can utilize as little or as many of the I/O interfaces as deemed necessary. The baseboard can therefore provide all the interface connectors required to attach the system to the application specific peripherals. This versatility allows the designer to create a dense and optimized package, which results in a more reliable product while simplifying system integration. Most importantly ETX applications are scalable, which means once a product has been created there is the ability to diversify the product range through the use of different performance class ETX modules. Simply unplug one module and replace it with another, no redesign is necessary.

XTX[™] is an expansion and continuation of the well-established and highly successful ETX standard. XTX offers the newest I/O technologies on this proven form factor. Currently, the ISA bus is found less often in modern embedded applications that offer a greater array of features. Consequently, the X2 connector for XTX replaces ISA with features that are currently not found on the ETX platform. These features include new serial high speed buses such as PCI Express[™], ExpressCard, AC'97 HD audio, and Serial ATA[®]. XTX also provides the AC'97 High Definition Audio (HDA) and two additional USB 2.0 ports, bringing the USB total to six USB ports. The USB 2.0 and PCI Express interfaces can also support the next generation PCMCIA card in the ExpressCard. All the other signals found on the X1, X3, and X4 connectors remain the same in accordance with the ETX standard (Rev. 2.7) and therefore will be completely compatible. If the embedded application still requires the ISA bus, then a PCI-ISA bridge can be implemented on the application specific baseboard. If this solution is too costly then the readily available XTX LPC bus located the Ampro XTX module can be used.

ETX or XTX modules work like a high-integration chip, plugging into your custom circuit board design to provide specific control for your logic application. See Figure 2-1.

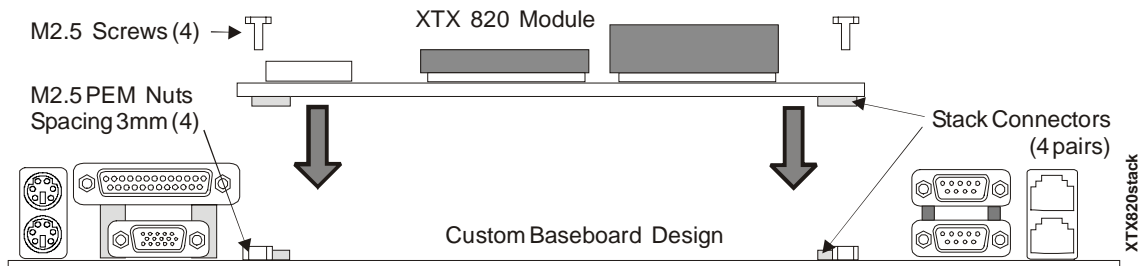

Figure 2-1. XTX 820 and Custom Baseboard

The XTX flexibility enables designers to take an accelerated, low risk path with proven XTX module designs. Your design flow might look similar to the one shown in Figure 2-2. This diagram gives a Typical Design Flow of hardware and software functions.

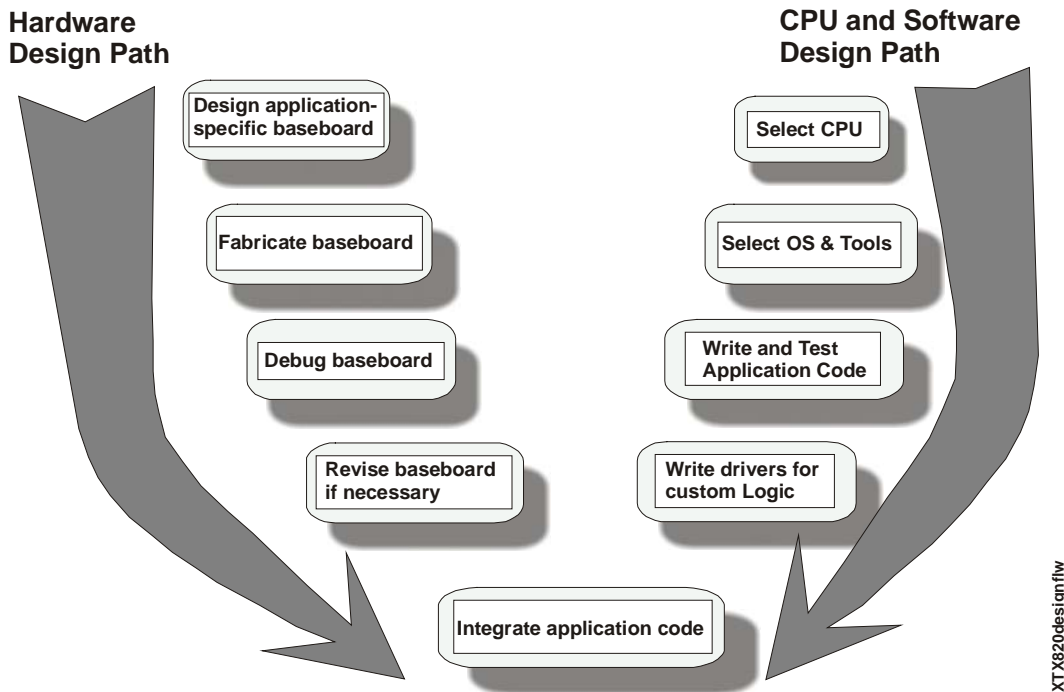

Figure 2-2. Typical Design Flow

Product Description

The XTX 820 is an exceptionally high integration, high performance, rugged, and high quality Computer-On-Module (COM), which contains all the component subsystems of a PC/AT motherboard plus the equivalent of up to 5 expansion boards. The XTX 820 is based on the ultra high performance, high-integration Intel Pentium M and Celeron M processors giving designers the choice of a complete, high performance, rugged, embedded processor based on the XTX form factor that conforms to the ETX V2.7 specification. The module plugs into a custom baseboard which has connectors and additional circuitry to meet your application requirements.

Each XTX 820 incorporates an Intel® 915GM chipset (82915GM + 82801FBM). This includes the Intel 82915GM Memory & Graphics Hub (Northbridge), which controls the memory and graphics interface and the Intel 82801FBM I/O Hub (Southbridge) controller for some of the important I/O functions. A Super I/O chip (83627HG) by Winbond Electronics, Corp controls most of I/O functions. Together these three chips provide four x1 PCI Express Lanes, PCI bus, two Serial ATA ports and one Ultra/DMA 33/66/100 EIDE controller for two EIDE drives, six USB 2.0 ports, one shared EPP/ECP parallel/ floppy port, two serial ports with TTL levels, one Infrared (IrDA) port, PS/2 keyboard and mouse interfaces, and an AC'97/HDA (High Definition Audio) CODEC on the module. The XTX 820 also supports ACPI 2.0 Power Management, 10/100BaseT Ethernet interface, up to 1 GB of DDR2 RAM in a single 200-pin SODIMM socket, and a 128-bit graphics controller, which provides CRT (VGA), a dedicated LVDS port, TV Out, and two SDVO port interfaces.

The XTX 820 is particularly well suited to either embedded or portable applications and meets the size, power consumption, temperature range, quality, and reliability demands of embedded system applications. The XTX 820 requires only a single +5V power supply.

Board Features

- CPU features
 - ◆ Intel Celeron M 373 1.0 GHz with 512 kbytes L2 cache
 - ◆ Intel Pentium M 738 1.4 GHz with 2 Mbytes L2 cache
 - ◆ Intel Pentium M 745 1.8 GHz with 2 Mbytes L2 cache
 - ◆ All three CPUs use 400 MHz front side bus (FSB)
- Memory
 - ◆ Single standard 200-pin DDR2 SODIMM socket
 - ◆ Supports +1.8V RAM up to 1 GB
 - ◆ Supports PC2 3200 DDR2 400 (400 Mbps, 200 MHz)
- Power Management
 - ◆ Supports ACPI 2.0 with S3 (Suspend to RAM)
- PCI Bus
 - ◆ PCI 2.1 compliant
 - ◆ PCI Bus speed at 33 MHz
- PCI Express
 - ◆ Supports 4 x1 PCI Express Lanes
 - ◆ Supports PCI Express edge card or ExpressCards on custom baseboard
 - ◆ Supports PCI Express specification v1.0a
- LPC Bus
 - ◆ Provides low-bandwidth support through low pin count (LPC) bus
 - ◆ Provides substitute for ISA bus with Super I/O chip on baseboard
- IDE/ATA Interfaces
 - ◆ Supports two Serial ATA interfaces
 - ◆ Supports one EIDE channel (UDMA 66/100)
 - ◆ Supports ATAPI and DVD peripherals
 - ◆ Supports IDE native and ATA compatibility modes
- Floppy Disk Interface
 - ◆ Shares output connector with Parallel port
 - ◆ Supports one standard (34-pin) floppy drive
 - ◆ Supports all standard PC/AT formats: 360KB, 1.2MB, 720KB, 1.44MB
- Serial Ports
 - ◆ Provides two buffered TTL serial ports with full handshaking (transceiver on baseboard)
 - ◆ Provides 16550-equivalent controllers, each with a built-in 16-byte FIFO buffer
 - ◆ Supports full modem capability
 - ◆ Supports programmable word length, stop bits, and parity
 - ◆ Supports 16-bit programmable baud-rate generator and a interrupt generator.

- Infrared Interface
 - ◆ Supports a single IrDA 1.1 port
 - ◆ Supports HPSIR and ASKIR infrared modes
- Parallel Port
 - ◆ Shares output connector with Floppy controller
 - ◆ Supports standard printer port
 - ◆ Supports IEEE standard 1284 protocols of EPP and ECP outputs
 - ◆ Bi-directional data lines
 - ◆ Supports 16 byte FIFO for ECP mode.
- USB Ports
 - ◆ Supports three root USB hubs
 - ◆ Supports six USB ports
 - ◆ Supports USB v2.0 (EHCI) and legacy v1.1
 - ◆ Supports over-current fuses on board
- Keyboard/Mouse Interface
 - ◆ Supports PS/2 keyboard
 - ◆ Supports PS/2 mouse
- Audio interface
 - ◆ Supports AC'97 standard
 - ◆ AC'97 HDA (High Definition Audio) CODEC on board
 - ◆ Supports audio amplifier on baseboard
- Ethernet Interface
 - ◆ Supports one Ethernet port
 - ◆ I/O Hub (Southbridge) provides MAC Ethernet Controller
 - ◆ Intel 82562GZ provides the PHY Ethernet interface
 - ◆ Requires magnetics and RJ45 connector on baseboard
 - ◆ Supports IEEE 802.3 10BaseT/100BaseTX compatible physical layer
 - ◆ Supports Auto-negotiation for speed, duplex mode, and flow control
 - ◆ Supports full duplex or half-duplex mode
 - Full-duplex mode supports transmit and receive frames simultaneously
 - Supports IEEE 802.3x Flow control in full duplex mode
 - Half-duplex mode supports enhance proprietary collision reduction mode
- Video Interfaces (CRT/LVDS/TV Out/SDVO)
 - ◆ Support CRT resolutions up to 2048x1536 @ 75 Hz (QXGA)
 - ◆ ◆ Supports 8-bits for each RGB DAC or 24-bit RAMDACSupports up to 128 MB of system memory
 - ◆ System memory is allocated using Dynamic Video Memory Technology (DVMT) v3.0
 - ◆ Supports Dual independent display

- ◆ Supports 25 to 112 MHz single/dual channel LVDS with Spread Spectrum Clocking (SSC)
- ◆ Supports TFT format of 1x18 bpp per channel and 2x18 bpp for 2 channels
- ◆ Supports LVDS panel size up to UXGA (1600 x 1200)
- ◆ Provides TV Out to the baseboard
- ◆ Supports Composite and S-Video up to 1024 x 768 resolution for NTSC/PAL
- ◆ Supports Component Video in 480p/720p/1080i/1080p modes
- ◆ Provides two Intel compliant SDVO (Serial Digital Video Output) ports
- ◆ Supports SDVO pixel rates up to 200 MP/s (600 MB/s) transfer speed on each port
- Miscellaneous
 - ◆ Provides Real-Time Clock (RTC) supported by external battery on baseboard
 - ◆ Supports Remote Access (Serial Console or Console Redirection)
 - ◆ Supports Watchdog Timer (WDT)
 - ◆ Supports customizable Splash Screen (OEM Logo)

Block Diagram

Figure 2-3 shows the functional components of the board.

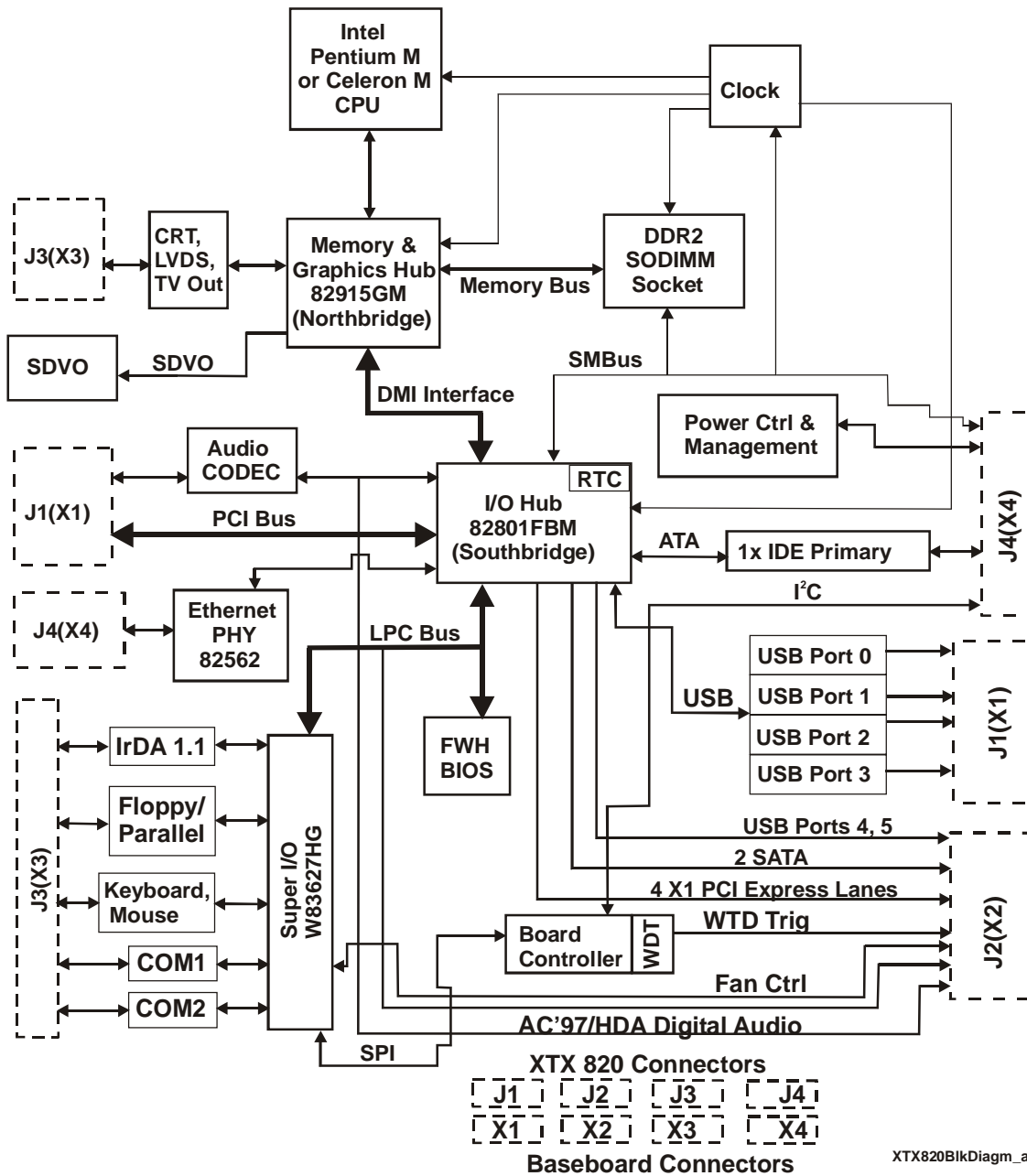

Figure 2-3. Functional Block Diagram

Major Integrated Circuits (ICs)

Table 2-1 lists the major integrated circuits (ICs or chips), including a brief description, on the XTX 820 module and Figure 2-4 shows the location of the major chips.

Table 2-1. Major Integrated Circuit Description and Function

Chip Type	Mfg.	Model	Description	Function
CPU (U6)	Intel	Celeron M or Pentium M	CPUs at 1.0 GHz, 1.4 GHz, and 1.8 GHz	Embedded CPU
Memory & Graphics Hub (U8)	Intel	82915GM (GMHC)	Northbridge functions plus Video	Memory and Video
I/O Hub (U4)	Intel	82801FBM (ICH6M)	Provides most standard I/O Southbridge functions plus Ethernet MAC functions	I/O Functions Plus Ethernet
Super I/O (U11)	Winbond	83627HG	Provides remainder of I/O functions	I/O Functions
Ethernet (U3)	Intel	82562GZ	Uses MAC from I/O Hub to provide Ethernet Controller	Physical Ethernet
Audio (U21)	Realtek	ALC655	Audio CODEC controller	AC'97 Audio

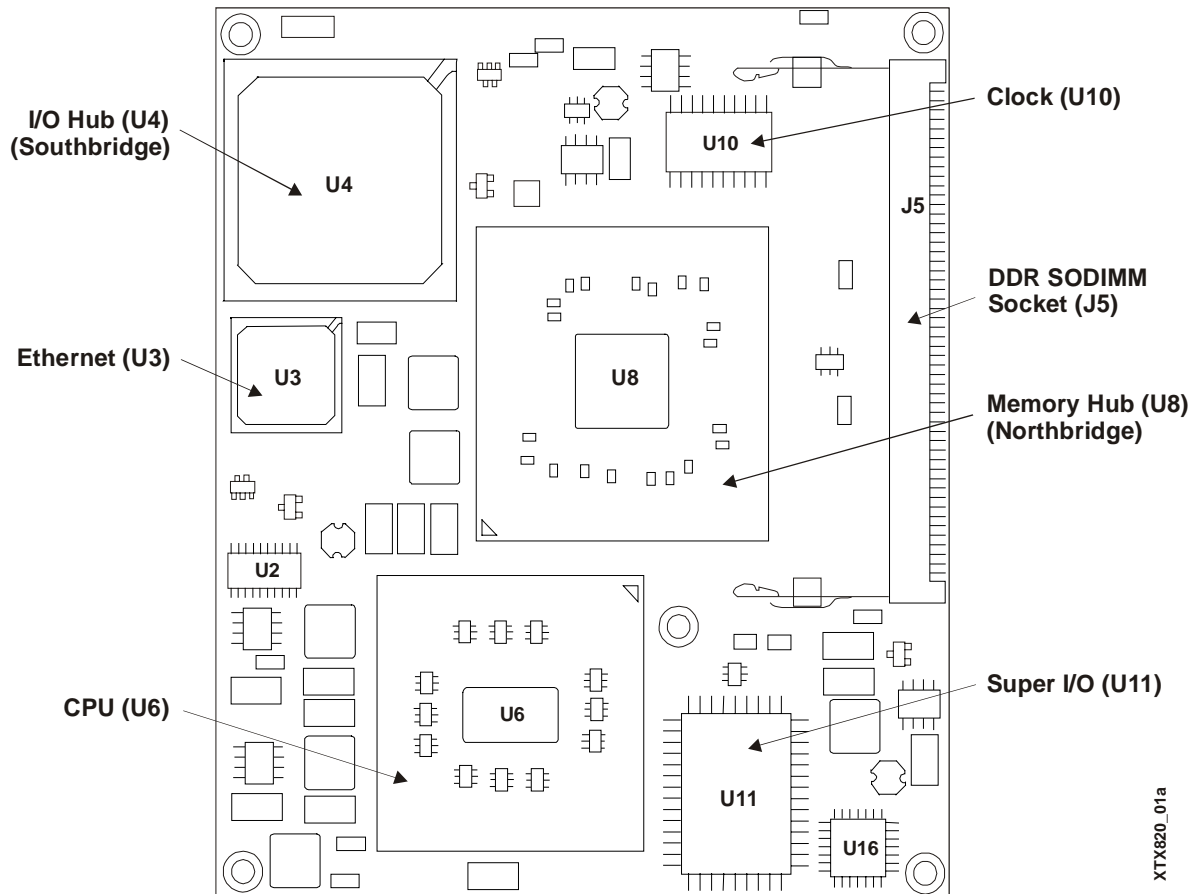

XTX820_01a

Figure 2-4. XTX 820 (Top view)

Connector Definitions

Table 2-2 describes the connectors shown in Figures 2-4 and 2-5.

Table 2-2. Board Connector Descriptions

No.	Signals	Description
J1	PCI, USB, Audio	100-pin connector for 32-bit PCI, USB (4 ports), and Audio
J2	PCI Express, SATA	100-pin connector for PCI Express, 2x SATA, USB (2 ports), LPC, ExpressCards (2), AC'97/HDA Audio, extended system management
J3	Video, I/O	100-pin connector for Video (VGA, LVDS) and I/O (Floppy/Parallel, Serial Ports 1 & 2, and Infrared) signals
J4	IDE, Ethernet	100-pin connector for IDE (Primary & Secondary IDE), I ² C bus, Power Management, and the Ethernet port
J5	DDR2 Memory	200-pin socket for a DDR2 SODIMM RAM
J6	SDVO port	45-pin Serial Digital Video Output ports (2)

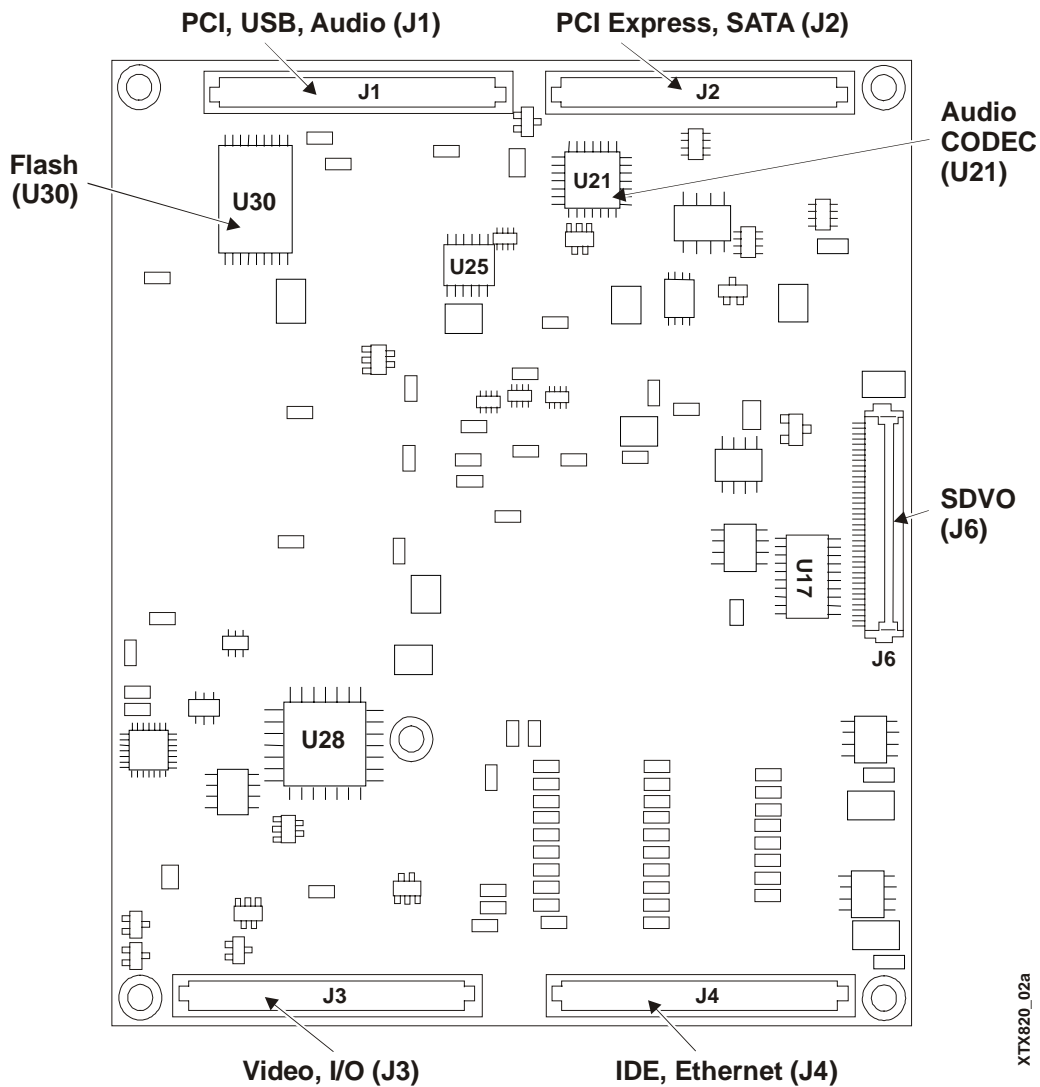

Figure 2-5. Connector Locations (Bottom view)

XTX820_02a

Power Specifications

Table 2-4 lists the power requirements for each XTX 820 CPU model as described below.

Table 2-4. Power Supply Requirements

Parameter	1.0 GHz ULV Celeron M Characteristics	1.4 GHz LV Pentium M Characteristics	1.8 GHz LV Pentium M Characteristics
Input Type	Regulated DC voltages	Regulated DC voltages	Regulated DC voltages
In-rush Current*	14.20A	16.20A	14.16A
Typical BIT** Current (W)	3.34A (16.71W)	3.89A (19.46W)	5.31A (26.57W)

Notes: *The In-rush current represents video, 256 MB RAM, and power only connected through the Ampro baseboard. Typically, in-rush current reflects the short duration current spike associated with charging large on-board bulk capacitance during power supply start up. However, the listed in-rush current value is the result of placing a switch on the DC output of a fully 'ramped' power supply to give a worst-case current value, which is much higher than the standard method. This in-rush value should be regarded as a maximum design guideline, not a requisite value.

**The Burn-In-Test (BIT) current setup has CRT video, 256 MB RAM, floppy drive (1), IDE hard disk drive (1), USB hard disk drive (1), USB CD-ROM (1), serial ports with loopbacks (3), keyboard, mouse, USB compact flash card reader with compact flash card (64 MB) installed (1), USB Jump-drive (1), and the Ethernet port (1) operating under Microsoft® Windows®™ XP (SP2). All current measurements include the Ampro baseboard in the QuickStart Kit.

Environmental Specifications

Table 2-5 provides the most efficient operating and storage condition ranges required for this board.

Table 2-5. Environmental Requirements

	Parameter	1.0 GHz ULV Celeron M Conditions	1.4 GHz LV Pentium M Conditions	1.8 GHz LV Pentium M Conditions
Temperature	Operating	+0° to +60°C (32° to +158°F)	+0° to +60°C (32° to +158°F)	+0° to +60°C (32° to +140°F)
	Storage	-20° to +75°C (-4° to +185°F)	-20° to +75°C (-4° to +185°F)	-20° to +75°C (-4° to +185°F)
Humidity	Operating	5% to 95% relative humidity, non-condensing	5% to 95% relative humidity, non-condensing	5% to 95% relative humidity, non-condensing
	Storage	5% to 95% relative humidity, non-condensing	5% to 95% relative humidity, non-condensing	5% to 95% relative humidity, non-condensing

Thermal/Cooling Solutions

The Pentium/Celeron M processors used on the XTX 820 make use of the thermal monitor feature to help control the processor temperature. Refer to the *Thermal Monitoring* topic in Chapter 3, Hardware for more information. The maximum core operating temperature for Pentium M and Celeron M processors is 100°C. Both Pentium M and Celeron M processors and the Memory & Graphics Hub (Northbridge) require individual heatsinks, but no fan. Ampro provides an optional heatspreader plate.

CAUTION	To prevent processor overheating, you must provide an additional form of cooling when using the heatspreader provided. The heatspreader plate is not a complete thermal solution for any of the processors listed.
----------------	--

Chapter 3 Hardware

Overview

This chapter discusses the chips and features of the connectors in the following order:

- CPU (U1)
- Memory
- PCI Bus Interface (J1)
 - ◆ USB Interface
 - ◆ Audio Interface
- PCI Express (J2)
 - ◆ Serial ATA (SATA)
 - ◆ ExpressCards
 - ◆ AC'97/HDA
 - ◆ LPC bus
- Primary I/O Interface (J3)
 - ◆ Floppy/Parallel Interface
 - ◆ Serial Port Interfaces
 - ◆ PS/2 Keyboard and Mouse
 - ◆ Infrared (IrDA)
 - ◆ Video Interfaces (CRT & LVDS)
- IDE and Auxiliary Interface (J4)
 - ◆ Primary IDE Interface
 - ◆ Ethernet Interface
 - ◆ Time of Day (RTC)/Battery and Speaker
 - ◆ Power Control and Management
 - ◆ SMBus
- Miscellaneous
 - ◆ Serial Console (Remote Access)
 - ◆ Temperature Monitoring
 - ◆ Watchdog timer
 - ◆ Power

NOTE

Ampro Computers, Inc. only supports the features/options tested and listed in this manual. The main integrated circuits (chips) used in the XTX 820 may provide more features or options than are listed for the XTX 820, but some of these chip features/options are not supported on the board and will not function as specified in the chip documentation.

CPU (U1)

The XTX 820 offers three Intel processor choices; high performance 1.0 GHz Ultra Low Voltage (ULV) Celeron M CPU, 1.4 GHz Low Voltage (LV) Pentium M CPU, or 1.8 GHz Pentium M CPU.

Celeron M Processor

The Celeron M processor (Dothan core) at 1.0 GHz has 512 kB L2 Cache with a 400 MHz FSB (front side bus). The 1.0 GHz Celeron M 373 processor use 90 nm architecture and requires a heatsink, but no fan.

Pentium M Processors

The Pentium M 738 processor (Dothan core) at 1.4 GHz has 2 MB L2 Cache with a 400 MHz FSB (front side bus). The 1.4 GHz Pentium M 738 processor uses 90 nm architecture and requires a heatsink, but no fan.

The Pentium M 745 processor (Dothan core) at 1.8 GHz has 2 MB L2 Cache with a 400 MHz FSB (front side bus). The 1.8 GHz Pentium M 745 processor uses 90 nm architecture and requires a heatsink, but no fan below 60°C.

CAUTION If you choose to use a heat-spreader plate instead of an individual heatsink for the processor, then you must provide an additional form of cooling. The heat-spreader plate is not a complete thermal solution for any of the processors listed.

Memory

The XTX 820 memory consists of the following elements:

- DDR2 SODIMM socket
- Flash memory

DDR2 SODIMM Socket (J5)

The XTX 820 supports a single 200-pin DDR2 SODIMM socket.

- SODIMM socket (J5) can support up to 1 GB of DDR2 memory
- Supports PC2 3200 DDR 400 operating at 400 Mbps (200 MHz, 5 ns) or faster
- Supports +1.8V SDRAM

NOTE Ampro recommends using PC2 3200 DDR2 400 (400 Mbps, 200 MHz), +1.8V, 5 ns, 200-pin, SDRAM SODIMM, or faster. PC2 3200 provides the best performance for these Intel processors.

Flash Memory (U17)

There is an 8-bit wide, 512 kB flash device used for system BIOS and is connected to the I/O Hub (Southbridge), through an LPC bus transceiver. The flash memory is used to store system parameters for battery-free boot capability when there is no battery present. The BIOS is re-programmable and the features supported are detailed in Chapter 4, *BIOS Setup Utility*.

Interrupt Channel Assignments (IRQs)

The channel interrupt assignments are listed in Table 3-1.

Table 3-1. Interrupt Channel Assignments (IRQs)

IRQ#	Available	Typical Interrupt Source	Connected to Pin
0	No	Counter 0	NA
1	No	Keyboard	NA
2	No	Cascade Interrupt from Slave PIC	NA
3	Note 1	Serial Port 2 (COM2) / Generic	IRQ3 via SERIRQ
4	Note 1	Serial Port 1 (COM1) / Generic	IRQ4 via SERIRQ
5	Note 2	Parallel Port 2 (LPT2) / Generic	IRQ5 via SERIRQ
6	Note 1	Floppy Drive Controller / Generic	IRQ6 via SERIRQ
7	Note 1	Parallel Port 1 (LPT1) / Generic	IRQ7 via SERIRQ
8	No	Real-time Clock	NA
9	Note 4	SCI / Generic	IRQ9 via SERIRQ
10	Note 2, 1	Serial Port 3 (COM3) / Generic	IRQ10 via SERIRQ
11	Note 2, 1	Serial Port 4 (COM4) / Generic	IRQ11 via SERIRQ
12	Note 1	PS/2 Mouse / Generic	IRQ12 via SERIRQ
13	No	Math processor	NA
14	Note 1, 3	IDE Controller 0 (IDE0) / Generic	IRQ14
15	Note 1, 3	IDE Controller 1 (IDE1) / Generic	IRQ15

Notes: In PIC mode, the PCI bus interrupt lines can be routed to any free IRQ.

1. Default, but can be changed to another interrupt. If disabled in BIOS Setup, the interrupt can be used for another purpose.
2. Function described is available if the baseboard is equipped with the Super I/O controller Winbond (W83627HG). This I/O controller is supported by the XTX 820 Embedded BIOS.
3. If the ATA/IDE configuration is set to enhanced mode in BIOS setup (serial ATA and parallel ATA native mode operation), IRQ14 and 15 are free for PCI/LPC bus.
4. In ACPI mode, IRQ9 is used for the SCI (System Control Interrupt). The SCI can be shared with a PCI interrupt line.

Memory Map

The following table provides the common PC/AT memory allocations. Memory below 000500h is used by the BIOS.

Table 3-2. Memory Map

Address Range (decimal)	Address Range (hex)	Size	Description
(TOM-192kB) to TOM	NA	192 kB	ACPI reclaim, MPS and NVS area **
(TOM-8MB-192kB) to (TOM-192kB)	NA	1 or 8 MB	VGA frame buffer *
1024 k to (TOM- 8MB -192kB)	100000 - N.A	NA	Extended memory
869 k - 1024 k	E0000 - FFFFF	128 kB	Runtime BIOS
800 k - 869 k	CC000 - DFFFF	96 kB	Upper memory
640 k - 800 k	A0000 - CBFFF	160 kB	Video memory and Video BIOS

Address Range (decimal)	Address Range (hex)	Size	Description
639 k - 640 k	9FC00 - 9FFFF	1 kB	Extended BIOS data
0 - 639k	00000 - 9FC00	512 kB	Conventional memory

- Notes:**
- T.O.M. = Top of memory = max. DRAM installed
 - * VGA frame buffer can be reduced to 1MB in setup.
 - ** Only if ACPI Aware OS is set to YES in setup.

I/O Address Map

Table 3-3 list the I/O address map.

Table 3-3. I/O Address Map

I/O Address (hex)	Size	Available	Description
0000 – 00FF	256 bytes	No	Baseboard resources
0100 – 0110	16 bytes	No	System Control
0170 – 0177	8 bytes	No	Secondary IDE channel
01F0 – 01F7	8 bytes	No	Primary IDE channels
0278 – 027F	8 bytes	Note 2	Parallel Port 2 (LPT2)
02E8 – 02EF	8 bytes	Note 2	Serial Port 4 (COM4)
02F8 – 02FF	8 bytes	Note 1	Serial Port 2 (COM2)
0376	1 byte	No	Secondary IDE channel command port
0377	1 byte	No	Secondary IDE channel status port
0378 – 037F	8 bytes	Note 1	Parallel Port 1 (LPT1)
03B0 – 03DF	16 bytes	No	Video system
03E8 – 03EF	8 bytes	Note 2	Serial Port 3 (COM3)
03F0 – 03F5	6 bytes	No	Floppy channel 1
03F6	1 byte	No	Primary IDE channel command port
03F7	1 byte	No	Primary IDE channel status port
03F8 – 03FF	8 bytes	Note 1	Serial Port 1 (COM1)
0480 – 04BF	64 bytes	No	Baseboard resources
04D0 – 04D1	2 bytes	No	Baseboard resources
0800 – 087F	128 bytes	No	Baseboard resources
0A00 – 0A0F	16 bytes	No	Baseboard resources
0CF8 – 0CFB	4 bytes	No	PCI configuration address register
0CFC – 0CFF	4 bytes	No	PCI configuration data register
0D00 – FFFF		Note 3	PCI / PCI Express bus

- Notes:**
1. Default, but can be changed to another address range.
 2. When baseboard external Super I/O controller is present.
 3. The BIOS assigns PCI and PCI Express I/O resources from FFF0h downwards. Non PnP/PCI/PCI Express compliant devices must not consume I/O resources in that area.

PCI Bus Interface Connector (J1)

The J1 connector has 100 pins and is used for the PCI bus, USB ports, IRQ lines, and Audio (AC'97) interface connections.

Tables 3-4 to 3-7 provide the signals and descriptions in a simplified form and Table 3-8 provides the complete pin-outs for the X1 connector.

PCI Bus

The Memory & Graphics Hub (Northbridge) chip (82915GM) integrates a PCI arbiter that supports up to four external PCI masters.

- This interface carries all of the appropriate PCI signals
- Operates at clock speeds up to 33 MHz.
- PCI 2.1 Compliant, 32-bit 3.3V PCI interface with 5V tolerant inputs

Table 3-4. Simplified PCI Pin/Signal Descriptions (J1)

J1 Pin #	Signal	PCI Pin #	Description
NC	TRST*	1 (A1)	Test Reset – This signal provides an asynchronous initialization of the TAP controller. One of five pins used for the optional JTAG/Boundary Scan and TAP function.
NC	+12V	2 (A2)	+12 Volt Power
NC	TMS	3 (A3)	Test Mode Select – This signal is used to control the state of the TAP controller in the device. One of five pins used for the optional JTAG/Boundary Scan and TAP function.
NC	TDI	4 (A4)	Test Data Input is used to serially shift test data and test instructions into the device during TAP operation. One of five pins used for the optional JTAG/Boundary Scan and TAP function.
NC	+5V	5 (A5)	+5 Volt Power
97	INTA*	6 (A6)	Interrupt A – This signal is used to request an interrupt.
95	INTC*	7 (A7)	Interrupt C – This signal is used to request an interrupt.
NC	+5V	8 (A8)	+5 Volt Power
	Reserved	9 (A9)	Reserved
	+3.3V I/O	10 (A10)	+3.3V I/O
	Reserved	11 (A11)	Reserved
NC	Key (3.3V)	12 (A12)	+3.3V Key
NC	Key (3.3V)	13 (A13)	+3.3V Key
	3.3Vaux	14 (A14)	3.3 Volt Auxiliary – This voltage is an optional power source that delivers power to the PCI add-in card for generation of power management events when the main power to the card has been turned off by software. A system or add-in card that does not support PCI bus power management must treat the 3.3Vaux pin as reserved.
93	PCIRST*	15 (A15)	(PCI Bus) Reset – This signal is used to bring PCI-specific registers, sequencers, and signals to a consistent state. Anytime Reset is asserted, all PCI output signals must be driven to the benign state.
	+3.3V(I/O)	16 (A16)	+3.3V I/O

J1 Pin #	Signal	PCI Pin #	Description
	GNT*	17 (A17)	Grant – This is a point-to-point signal and indicates to the agent that access to the bus has been granted. Every master has its own GNT, which must be ignored while RST is asserted.
	Ground	18 (A18)	Ground
57	PME*	19 (A19)	Power Management Event – This signal is an optional signal that can be used by a device to request a change in the device or system power state.
91	AD30	20 (A20)	Address/Data bus 30 – These signals (AD31 – AD0) are multiplexed on the same PCI connector pins. During the address phase of a PCI cycle, AD31–AD0 contain a 32-bit address or other destination information. During the data phase, AD31 – AD0 contain data.
	+3.3V	21 (A21)	+3.3 Volt Power
87	AD28	22 (A22)	Address/Data bus 28 – Refer to Pin-20 (A20) for more information
86	AD26	23 (A23)	Address/Data bus 26 – Refer to Pin-20 (A20) for more information
	Ground	24 (A24)	Ground
81	AD24	25 (A25)	Address/Data bus 24 – Refer to Pin-20 (A20) for more information)
60	DEVSEL	26 (A26)	Initialization Device Select – This signal is used as a chip select during configuration read and write transactions.
	+3.3V	27 (A27)	+3.3 Volt Power
77	AD22	28 (A28)	Address/Data bus 22 – Refer to Pin-20 (A20) for more information
75	AD20	29 (A29)	Address/Data bus 20 – Refer to Pin-20 (A20) for more information
	Ground	30 (A30)	Ground
74	AD18	31 (A31)	Address/Data bus 18 – Refer to Pin-20 (A20) for more information
69	AD16	32 (A32)	Address/Data bus 16 – Refer to Pin-20 (A20) for more information
	+3.3V	33 (A33)	+3.3 Volt Power
65	FRAME*	34 (A34)	PCI bus Frame access – This signal is driven by the current master to indicate the start of a transaction and will remain active until the final data cycle.
	Ground	35 (A35)	Ground
61	TRDY*	36 (A36)	Target Ready – This signal indicates the selected device’s ability to complete the current cycle of transaction. Both IRDY* and TRDY* must be asserted to terminate a data cycle.
	Ground	37 (A37)	Ground
64	STOP*	38 (A38)	Stop – This signal is driven by the current PCI target to request the master to stop the current transaction.
	+3.3V	39 (A39)	+3.3 Volt Power
	Reserved*	40 (A40)	Reserved
	Reserved*	41 (A41)	Reserved
	Ground	42 (A42)	Ground
53	PAR	43 (A43)	PCI bus Parity bit – This signal is the even parity bit on AD[31:0] and CBE[3:0]*.
47	AD15	44 (A44)	Address/Data bus 15 – Refer to Pin-20 (A20) for more information
	+3.3V	45 (A45)	+3.3 Volt Power

J1 Pin #	Signal	PCI Pin #	Description
43	AD13	46 (A46)	Address/Data bus 13 – Refer to Pin-20 (A20) for more information
39	AD11	47 (A47)	Address/Data bus 11 – Refer to Pin-20 (A20) for more information
	GND	48 (A48)	Ground
34	AD9	49 (A49)	Address/Data bus 9 – Refer to Pin-20 (A20) for more information
NC	Key	50 (A50)	+5 Volt Key
NC	Key	51 (A51)	+5 Volt Key
31	CBE0*	52 (A52)	PCI Bus Command/Byte Enable 0 – This signal line is one of four signal lines multiplexed on the same pins, so that during the address cycle, the command is defined and during the data cycle, the byte enable is defined.
	+3.3V	53 (A53)	+3.3 Volt Power
29	AD6	54 (A54)	Address/Data bus 06 – Refer to Pin-20 (A20) for more information
27	AD4	55 (A55)	Address/Data bus 04 – Refer to Pin-20 (A20) for more information
	Ground	56 (A56)	Ground
26	AD2	57 (A57)	Address/Data bus 02 – Refer to Pin-20 (A20) for more information
23	AD0	58 (A58)	Address/Data bus 00 – Refer to Pin-20 (A20) for more information
	+3.3V(I/O)	59 (A59)	+3.3V I/O
NC	REQ64*	60 (A60)	Request 64-bit Transfer – This signal, when asserted by the current bus master, indicates it desires to transfer data using 64 bits. Not used in 32-bit system.
NC	+5V	61 (A61)	+5 Volt Power
NC	+5V	62 (A62)	+5 Volt Power
NC	-12V	63 (B1)	-12 Volt Power
NC	TCK	64 (B2)	Test Clock – This signal is used to clock state information and test data into and out of the device during operation of the TAP. One of five pins used for the optional JTAG/Boundary Scan and TAP function.
	Ground	65 (B3)	Ground
NC	TDO	66 (B4)	Test Output – This signal is used to serially shift test data and test instructions out of the device during TAP operation. One of five pins used for the optional JTAG/Boundary Scan and TAP function.
NC	+5V	67 (B5)	+5 Volt Power
NC	+5V	68 (B6)	+5 Volt Power
98	INTB*	69 (B7)	Interrupt B – This signal is used to request an interrupt and only has meaning on a multi-function device.
96	INTD*	70 (B8)	Interrupt D – This signal is used to request an interrupt and only has meaning on a multi-function device.
NC	PRSNT1*	71 (B9)	Present 1 – These signals (Present 1::2) indicate to the motherboard if an add-in board is physically present in the slot and, if one is present, the total power requirements of the board. These signals are required for add-in boards but are optional for motherboards.
	Reserved	72 (B10)	Reserved
NC	PRSNT2*	73 (B11)	Present 2 – See pin-71 (B9) for more information.

J1 Pin #	Signal	PCI Pin #	Description
	Ground	74 (B12)	Ground
	Ground	75 (B13)	Ground
	Reserved	76 (B14)	Reserved
	Ground	77 (B15)	Ground
	CLK	78 (B16)	Clock – This signal provides timing for all transactions on the PCI bus and is an input to every PCI device.
	Ground	79 (B17)	Ground
	REQ*	80 (B18)	Request – This is a point-to-point signal and indicates to the arbiter that this agent desires use of the bus. Every master has its own Request which must be tri-stated while Reset is asserted.
	+3.3V(I/O)	81 (B19)	+3.3V I/O
94	AD31	82 (B20)	Address/Data bus 31 – Refer to Pin-20 (A20) for more information
90	AD29	83 (B21)	Address/Data bus 29 – Refer to Pin-20 (A20) for more information
	Ground	84 (B22)	Ground
89	AD27	85 (B23)	Address/Data bus 27 – Refer to Pin-20 (A20) for more information
85	AD25	86 (B24)	Address/Data bus 25 – Refer to Pin-20 (A20) for more information
	+3.3V	87 (B25)	+3.3 Volt Power
82	CBE3*	88 (B26)	Bus Command and Byte Enable 3 – Refer to Pin-52 (A52) for more information.
79	AD23	89 (B27)	Address/Data bus 23 – Refer to Pin-20 (A20) for more information
	Ground	90 (B28)	Ground
78	AD21	91 (B29)	Address/Data bus 21 – Refer to Pin-20 (A20) for more information
73	AD19	92 (B30)	Address/Data bus 19 – Refer to Pin-20 (A20) for more information
	+3.3V	93 (B31)	+3.3 Volt Power
71	AD17	94 (B32)	Address/Data bus 17 – Refer to Pin-20 (A20) for more information
70	CBE2*	95 (B33)	Bus Command and Byte Enable 2 – Refer to Pin-52 (A52) for more information.
	Ground	96 (B34)	Ground
63	IRDY*	97 (B35)	Initiator Ready – This signal indicates the master's ability to complete the current data cycle of the transaction.
	+3.3V	98 (B36)	+3.3 Volt Power
60	DEVSEL*	99 (B37)	Device Select – This signal is driven by the target device when its address is decoded.
	Ground	100 (B38)	Ground
59	LOCK*	101 (B39)	Lock – This signal indicates an operation that may require multiple transactions to complete.
55	PERR*	102 (B40)	Parity Error – This signal is driven by the PCI target during a write to indicate a data parity error has been detected.
	+3.3V	103 (B41)	+3.3 Volt Power
54	SERR*	104 (B42)	System Error – This signal is for reporting address parity errors.
	+3.3V	105 (B43)	+3.3 Volt Power

J1 Pin #	Signal	PCI Pin #	Description
49	CBE1*	106 (B44)	Bus Command and Byte Enable 1 – Refer to pin-52 (A52) for more information.
45	AD14	107 (B45)	Address/Data bus 14 – Refer to Pin-20 (A20) for more information
	GND	108 (B46)	Ground
41	AD12	109 (B47)	Address/Data bus 12 – Refer to Pin-20 (A20) for more information
37	AD10	110 (B48)	Address/Data bus 10 – Refer to Pin-20 (A20) for more information
NC	66 MHz/ Ground	111 (B49)	66 MHz Enable – This signal indicates to a device if the bus segment is operating at 66 or 33 MHz. Ground – If this pin is not used for 66 MHz operation, it is at ground potential.
	GND	112 (B50)	Ground for +3.3V boards
	GND	113 (B51)	Ground for +3.3V boards
33	AD08	114 (B52)	Address/Data bus 08 – Refer to Pin-20 (A20) for more information
32	AD07	115 (B53)	Address/Data bus 07 – Refer to Pin-20 (A20) for more information
	+3.3V	116 (B54)	+3.3 Volt Power
30	AD05	117 (B55)	Address/Data bus 05 – Refer to Pin-20 (A20) for more information
28	AD03	118 (B56)	Address/Data bus 03 – Refer to Pin-20 (A20) for more information
	Ground	119 (B57)	Ground
25	AD01	120 (B58)	Address/Data bus 01 – Refer to Pin-20 (A20) for more information
	+3.3V(I/O)	121 (B59)	+3.3V I/O
NC	ACK64*	122 (B60)	Acknowledge 64-bit Transfer – This signal indicates the target is willing to transfer data using 64 bits. Not used in 32-bit system.
NC	+5V	123 (B61)	+5 Volt Power
NC	+5V	124 (B62)	+5 Volt Power

Notes: The shaded area denotes power or ground. The signals marked with * = Negative true logic.

Universal Serial Bus (USB)

The XTX 820 COM supports up to six USB ports on the baseboard and the supported features are listed below.

- USB v2.0 backward compatible to legacy v.1.1
- Two root hubs and 4 ports on J1
- Two ports and 1 root hub on J2
- Supports USB boot of floppy disk drives, hard disk drives, CD-ROMs, or other USB boot devices
- Integrated physical layer transceivers
- Over-current detection status on USB ports 1 and 2

Table 3-5. Simplified USB Interface Pin/Signal Descriptions (J1)

J1 Pin #	Signal	Description
	USBP	USB Power –
76	USB0-	Universal Serial Bus Port 0 Data Negative Polarity
88	USB0+	Universal Serial Bus Port 0 Data Positive Polarity
80	USB1-	Universal Serial Bus Port 1 Data Negative Polarity
92	USB1+	Universal Serial Bus Port 1 Data Positive Polarity
58	USB2-	Universal Serial Bus Port 2 Data Negative Polarity
66	USB2+	Universal Serial Bus Port 2 Data Positive Polarity
62	USB3-	Universal Serial Bus Port 3 Data Negative Polarity
72	USB3+	Universal Serial Bus Port 3 Data Positive Polarity
	GND	USB Port ground

Note: The shaded area denotes power or ground.

Serial Interrupt Request

This SERIRQ signal is connected to serial request input on the I/O Hub (Southbridge) chip (82801FBM) for the alternative LPC/PCI interrupts. If this feature is supported, then DMA2 (Dack2 and DRQ2) shall not be supported by XTX 820 module.

Table 3-6. Simplified Serial Interrupt Request (J1)

J1 Pin #	Signal	Description
21	SERIRQ	Serial Interrupt Request – This pin is used to support the serial interrupt protocol.

AC'97 Sound

The XTX 820 module supports the AC'97 audio standard and the supported features are listed below.

- Provides Realtek ALC 655, AC'97/HDA (High Definition Audio CODECs)
- AC'97 Rev 2.2 compliant
- Supports audio amplifier on baseboard
- PC-Beep passthrough to Line Out while reset is held active low
- True Line Level Output with volume control independent of Line Out
- Digital 3V and 5V compliant

Table 3-7. Simplified Audio Interface Pin/Signal Descriptions (J1)

J1 Pin #	Signal	Description
38	AUXAL	Auxiliary A input Left – This signal is normally used for an external CD-ROM analog output or similar live-level audio source. Minimum input impedance is 5k Ohms and nominal input level is 1 volt RMS.
40	MIC	Microphone reference signal – This microphone input signal has a minimum input impedance of 5k Ohms, and the maximum input voltage is 0.15 V _{p-p} .
42	AUXAR	Auxiliary A input Right – This signal is normally used for an external CD-ROM analog output or similar live-level audio source. Minimum input impedance is 5k Ohms and nominal input level is 1 volt RMS.
44	ASVCC	Analog Supply Voltage – This test voltage is used for the sound controller, but is not available for customer use.
46	SNDL	Stereo Line Output Left channel – This output signal has a nominal level of 1 volt RMS into 10k impedance load. This output signal can not drive low-impedance speakers directly.
48	ASGND	Analog Ground – This ground is used for the sound controller and an external amplifier to achieved the lowest audio noise levels.
50	SNDR	Stereo Line Output Right channel – This output signal has a nominal level of 1 volt RMS into 10k impedance load. This output signal can not drive low-impedance speakers directly

Note: The shaded area denotes power or ground.

Table 3-8. Complete J1 Interface Pin/Signal Descriptions (J1)

Pin #	Signal	Description
1	GND	Ground
2	GND	Ground
3	PCICLK3	PCI clock 3 – This signal line is one of four signal lines. These clock signals provide the timing outputs for four external PCI devices and the timing for all transactions on the PCI bus.
4	PCICLK4	PCI clock 4 – Refer to pin-3 for more information.
5	GND	Ground
6	GND	Ground
7	PCICLK1	PCI clock 1 – Refer to pin-3 for more information.
8	PCICLK2	PCI clock 2 – Refer to pin-3 for more information.
9	REQ3*	Bus Request 3 – This signal line is one of four signal lines. These signals indicate to the arbitrator that the device desires use of the bus.
10	GNT3*	Grant 3 – This signal line is one of four signal lines. These signal lines indicate access has been granted to the requesting device (PCI Masters).
11	GNT2*	Grant 3 – Refer to pin 10 for more information.
12	+3.3V	+3.3 volts +/-%5
13	REQ2*	Bus Request 0 – This signal line is one of three signal lines. These signals indicate the device desires use of the bus to the arbitrator.
14	GNT1*	Grant 1 – Refer to pin 10 for more information.
15	REQ1*	Bus Request 1 – Refer to pin 9 for more information.
16	+3.3V	+3.3 volts +/-%5

Pin #	Signal	Description
17	GNT0*	Grant 0 – Refer to pin 10 for more information.
18	NC	Not Connected (Reserved)
19	VCC0	+5 volts +/-%5
20	VCC1	+5 volts +/-%5
21	SERIRQ	Serial Interrupt Request – This signal is used to support the serial interrupt protocol.
22	REQ0*	Bus Request 0 – Refer to pin 9 for more information.
23	AD0	Address/Data bus 0 – These signals (AD31 – AD0) are multiplexed on the same PCI connector pins. During the address phase of a PCI cycle, AD31–AD0 contain a 32-bit address or other destination information. During the data phase, AD31 – AD0 contain data.
24	+3.3V	+3.3 volts +/-%5
25	AD1	Address/Data bus 1 – Refer to pin-23 for more information.
26	AD2	Address/Data bus 2 – Refer to pin-23 for more information.
27	AD4	Address/Data bus 4 – Refer to pin-23 for more information.
28	AD3	Address/Data bus 3 – Refer to pin-23 for more information.
29	AD6	Address/Data bus 6 – Refer to pin-23 for more information.
30	AD5	Address/Data bus 5 – Refer to pin-23 for more information.
31	CBE0*	PCI Bus Command/Byte Enable 0 – This signal line is one of four signal lines multiplexed on the same pins, so that during the address cycle, the command is defined and during the data cycle, the byte enable is defined.
32	AD7	Address/Data bus 7 – Refer to pin-23 for more information.
33	AD8	Address/Data bus 8 – Refer to pin-23 for more information.
34	AD9	Address/Data bus 9 – Refer to pin-23 for more information.
35	GND	Ground
36	GND	Ground
37	AD10	Address/Data bus 10 – Refer to pin-23 for more information.
38	AUXA_L	Auxiliary A Input Left – This signal is normally used for an external CD-ROM analog output or similar live-level audio source. Minimum input impedance is 5k Ohms and nominal input level is 1 volt RMS.
39	AD11	Address/Data bus 11 – Refer to pin-23 for more information.
40	MIC	Microphone reference signal – This microphone input signal has a minimum input impedance of 5k Ohms, and the maximum input voltage is 0.15 Vp-p.
41	AD12	Address/Data bus 12 – Refer to pin-23 for more information.
42	AUXA_R	Auxiliary A Input Right – This signal is normally used for an external CD-ROM analog output or similar live-level audio source. Minimum input impedance is 5k Ohms and nominal input level is 1 volt RMS.
43	AD13	Address/Data bus 13 – Refer to pin-23 for more information.
44	VCCA_AUD	Analog Supply Voltage – This test voltage is used for the sound controller, but is not available for customer use.
45	AD14	Address/Data bus 14 – Refer to pin-23 for more information.
46	AOUT_L	Stereo Line Output Left channel – This output signal has a nominal level of 1 volt RMS into 10k impedance load. This output signal can not drive low-impedance speakers directly.

Pin #	Signal	Description
47	AD15	Address/Data bus 15 – Refer to pin-23 for more information.
48	ASGND	Analog Ground – This ground is used for the sound controller and an external amplifier to achieved the lowest audio noise levels.
49	CBE1*	Bus Command and Byte Enable 1 – Refer to pin-31 for more information.
50	AOUT_R	Stereo Line Output Right channel – This output signal has a nominal level of 1 volt RMS into 10k impedance load. This output signal can not drive low-impedance speakers directly
51	VCC2	+5 volts +/-%5
52	VCC3	+5 volts +/-%5
53	PAR	PCI bus Parity bit – This signal is the even parity bit on AD[31:0] and CBE[3:0]*.
54	SERR*	System Error – This signal is for reporting address parity errors.
55	PERR*	Parity Error – This signal is driven by the PCI target during a write to indicate a data parity error has been detected.
56	RESERVED	Reserved
57	PME*	Power Management Event – This signal is an optional signal that can be used by a device to request a change in the device or system power state.
58	USB2-	Universal Serial Bus Port 2 Data Negative Polarity
59	LOCK*	Lock – This signal indicates an operation that may require multiple transactions to complete.
60	DEVSEL*	Device Select – This signal is driven by the target device when its address is decoded.
61	TRDY*	Target Ready – This signal indicates the selected device’s ability to complete the current cycle of transaction. Both IRDY* and TRDY* must be asserted to terminate a data cycle.
62	USB3-	Universal Serial Bus Port 3 Data Negative Polarity
63	IRDY*	Initiator Ready – This signal indicates the master’s ability to complete the current data cycle of the transaction.
64	STOP*	Stop – This signal is driven by the current PCI target to request the master to stop the current transaction.
65	FRAME*	PCI bus Frame access – This signal is driven by the current master to indicate the start of a transaction and will remain active until the final data cycle.
66	USB2+	Universal Serial Bus Port 2 Data Positive Polarity
67	GND	Ground
68	GND	Ground
69	AD16	Address/Data bus 16 – Refer to pin-23 for more information.
70	CBE2*	Bus Command and Byte Enable 2 – Refer to pin-31 for more information.
71	AD17	Address/Data bus 17 – Refer to pin-23 for more information.
72	USB3+	Universal Serial Bus Port 3 Data Positive Polarity
73	AD19	Address/Data bus 19 – Refer to pin-23 for more information.
74	AD18	Address/Data bus 18 – Refer to pin-23 for more information.
75	AD20	Address/Data bus 20 – Refer to pin-23 for more information.

Pin #	Signal	Description
76	USB0-	Universal Serial Bus Port 0 Data Negative Polarity
77	AD22	Address/Data bus 22 – Refer to pin-23 for more information.
78	AD21	Address/Data bus 21 – Refer to pin-23 for more information.
79	AD23	Address/Data bus 23 – Refer to pin-23 for more information.
80	USB1-	Universal Serial Bus Port 0 Data Negative Polarity
81	AD24	Address/Data bus 24 – Refer to pin-23 for more information.
82	CBE3*	Bus Command and Byte Enable 3 – Refer to pin-31 for more information.
83	VCC4	+5 volts +/-%5
84	VCC5	+5 volts +/-%5
85	AD25	Address/Data bus 25 – Refer to pin-23 for more information.
86	AD26	Address/Data bus 26 – Refer to pin-23 for more information.
87	AD28	Address/Data bus 28 – Refer to pin-23 for more information.
88	USB0+	Universal Serial Bus Port 0 Data Positive Polarity
89	AD27	Address/Data bus 27 – Refer to pin-23 for more information.
90	AD29	Address/Data bus 29 – Refer to pin-23 for more information.
91	AD30	Address/Data bus 30 – Refer to pin-23 for more information.
92	USB1+	Universal Serial Bus Port 1 Data Positive Polarity
93	PCIRST*	PCI Bus Reset – This output signal is used to reset the entire PCI Bus and is asserted during a system reset.
94	AD31	Address/Data bus 31 – Refer to pin-23 for more information.
95	INTC*	Interrupt C – This signal is used to request an interrupt and only has meaning on a multi-function device.
96	INTD*	Interrupt D – This signal is used to request an interrupt and only has meaning on a multi-function device.
97	INTA*	Interrupt A – This signal is used to request an interrupt.
98	INTB*	Interrupt B – This signal is used to request an interrupt and only has meaning on a multi-function device.
99	GND	Ground
100	GND	Ground

Notes: The shaded area denotes power or ground. The signals marked with * = Negative true logic.

PCI Express Interface (J2)

The J2 connector has 100 pins and is used for PCI Express, Serial ATA (SATA), USB, ExpressCard, AC'97/HDA (High Definition Audio), and LPC bus.

PCI Express/ExpressCards

The I/O Hub (82801FBM) provides four x1 PCI Express lanes which can be configured to support PCI Express edge cards or two ExpressCards. If ExpressCards are used, one dedicated USB port and one dedicated PCI Express lane are required for each ExpressCard and SMBus is optional.

Table 3-9. PCI Express Interface Pin/Signal Descriptions (J2)

J2 Pin #	Signal	Description
69	PCIE0_RX-	PCI Express Lane 0, Receive Input, Negative Differential Line
71	PCIE0_RX+	PCI Express Lane 0, Receive Input, Positive Differential Line
75	PCIE0_TX-	PCI Express Lane 0, Transmit Output, Negative Differential Line
77	PCIE0_TX+	PCI Express Lane 0, Transmit Output, Positive Differential Line
53	PCIE1_RX-	PCI Express Lane 1, Receive Input, Negative Differential Line
55	PCIE1_RX+	PCI Express Lane 1, Receive Input, Positive Differential Line
59	PCIE1_TX-	PCI Express Lane 1, Transmit Output, Negative Differential Line
61	PCIE1_TX+	PCI Express Lane 1, Transmit Output, Positive Differential Line
39	PCIE2_RX-	PCI Express Lane 2, Receive Input, Negative Differential Line
37	PCIE2_RX+	PCI Express Lane 2, Receive Input, Positive Differential Line
33	PCIE2_TX-	PCI Express Lane 2, Transmit Output, Negative Differential Line
31	PCIE2_TX+	PCI Express Lane 2, Transmit Output, Positive Differential Line
17	PCIE3_RX-	PCI Express Lane 3, Receive Input, Negative Differential Line
15	PCIE3_RX+	PCI Express Lane 3, Receive Input, Positive Differential Line
11	PCIE3_TX-	PCI Express Lane 3, Transmit Output, Negative Differential Line
9	PCIE3_TX+	PCI Express Lane 3, Transmit Output, Positive Differential Line
5	PCIE_CLK_REF-	PCI Express Reference Clock, Negative Differential Line
3	PCIE_CLK_REF+	PCI Express Reference Clock, Positive Differential Line
41	EXC0_CPPE*	ExpressCard (capable card) Request (for slot 1)
43	EXC0_RST*	ExpressCard Reset Slot 1
21	EXC1_CPPE*	ExpressCard (capable card) Request (for slot 2)
23	EXC1_RST*	ExpressCard Reset (for slot 2)
63	PCE_WAKE*	PCI Express Wake Event

Notes: The shaded area denotes power or ground. The signals marked with * = Negative true logic.

Serial ATA

The I/O Hub (82801FBM) provides two Serial ATA150 connections through the J2 connector. Serial ATA is an enhancement of parallel ATA, but is not limited by the traditional restrictions of parallel ATA. Serial ATA has higher performance characteristics with respect to speed and EMV. Serial ATA starts with a transfer rate of 150 Mbytes/s as compared to the legacy Parallel ATA devices that were limited to ATA133 (133MHz) or slower (33/66/100 MHz). In the future, it is hoped that SATA can be expanded up to 600 Mbytes/s to accommodate future advanced developments. Serial ATA is completely protocol and software compatible to parallel ATA.

Table 3-10. Serial ATA Interface Pin/Signal Descriptions (J2)

Pin #	Signal	Description
4	SATA0_RX+	Serial ATA Channel 0, Receive Input, Positive Differential Line
6	SATA0_RX-	Serial ATA Channel 0, Receive Input, Negative Differential Line
12	SATA0_TX+	Serial ATA Channel 0, Transmit Output, Positive Differential Line
10	SATA0_TX-	Serial ATA Channel 0, Transmit Output, Negative Differential Line
16	SATA1_RX+	Serial ATA Channel 1, Receive Input, Positive Differential Line
18	SATA1_RX-	Serial ATA Channel 1, Receive Input, Negative Differential Line
24	SATA1_TX+	Serial ATA Channel 1, Transmit Output, Positive Differential Line
22	SATA1_TX-	Serial ATA Channel 1, Transmit Output, Negative Differential Line
28	SATA2_RX+	Serial ATA Channel 2, Receive Input, Positive Differential Line
30	SATA2_RX-	Serial ATA Channel 2, Receive Input, Negative Differential Line
40	SATA2_TX+	Serial ATA Channel 2, Transmit Output, Positive Differential Line
38	SATA2_TX-	Serial ATA Channel 2, Transmit Output, Negative Differential Line
44	SATA3_RX+	Serial ATA Channel 3, Receive Input, Positive Differential Line
46	SATA3_RX-	Serial ATA Channel 3, Receive Input, Negative Differential Line
54	SATA3_TX-	Serial ATA Channel 3, Transmit Output, Negative Differential Line
56	SATA3_TX+	Serial ATA Channel 3, Transmit Output, Positive Differential Line
58	IL_SATA*	Serial ATA Interlock Switch Input
50	SATALED*	Serial ATA Activity LED

Notes: The shaded area denotes power or ground. The signals marked with * = Negative true logic

Additional Universal Serial Bus (USB) Ports

The J2 connector supports two additional USB ports for a total of six USB ports for the baseboard. The features for these two additional USB ports are the same as the four USB ports on the J1 connector.

- Supports USB v2.0 and legacy v.1.1
- Supports one root hub for these two ports on (J2)

Table 3-11. USB 4 & 5 Interface Pin/Signal Descriptions (J2)

Pin #	Signal	Description
45	USBP4+	Universal Serial Bus Port 4, Positive Differential Line
47	USBP4-	Universal Serial Bus Port 4, Negative Differential Line
25	USBP5+	Universal Serial Bus Port 5, Positive Differential Line
27	USBP5-	Universal Serial Bus Port 5, Negative Differential Line

Note: The shaded area denotes power or ground.

AC'97/HDA CODEC

The additional signals provided by J2 support AC'97 digital audio CODECs as well HDA (High Definition Audio) audio CODECs.

Table 3-12. Audio CODEC Interface Pin/Signal Descriptions (J2)

Pin #	Signal	Description
81	AC_RST*	AC'97/HDA CODEC Reset
85	AC_SYNC	AC'97/HDA Serial Bus Synchronization
89	AC_BIT_CLK	AC'97/HDA 12.228 MHz Serial Bit Clock from CODEC
82	AC_SDOOUT	AC'97/HDA Audio Serial Data Output to CODEC
86	AC_SDIN0	AC'97/HDA Audio Serial Data Input from CODEC0
87	AC_SDIN1	AC'97/HDA Audio Serial Data Input from CODEC1
88	AC_SDIN2	AC'97/HDA Audio Serial Data Input from CODEC2
79	CODECSET	AC'97/HDA Disable onboard Audio CODEC

Notes: The shaded area denotes power or ground. The signals marked with * = Negative true logic.

LPC Interface

The LPC (Low Pin Count) bus is provided as a replacement for the increasingly less often used ISA bus. The LPC bus is used on PC-style personal computers to connect low-bandwidth devices to the CPU, such as the boot ROM, "legacy" I/O devices (supported by a Super I/O chip), and audio controllers. The "legacy" I/O devices usually include serial and parallel ports, keyboard, mouse, and a floppy disk controller. Due to the software compatibility of the LPC bus to the ISA bus, I/O devices such as additional serial ports can be easily implemented on an application specific baseboard using the LPC bus. There are also many devices available for the LPC bus.

Table 3-13. LPC Interface Pin/Signal Descriptions (J2)

Pin #	Signal	Description
91	LPC_AD0	LPC Multiplexed Command, Address and Data Line 0
93	LPC_AD1	LPC Multiplexed Command, Address and Data Line 1
94	LPC_FRAME*	LPC Frame – Indicates start of a new or termination of a broken cycle.
95	LPC_AD2	LPC Multiplexed Command, Address and Data Line 2
96	LPC_DRQ0*	LPC Encoded DMA/Bus Master Request Line 0
97	LPC_AD3	LPC Multiplexed Command, Address and Data Line 3
98	LPC_DRQ1*	LPC Encoded DMA/Bus Master Request Line 1

Notes: The shaded area denotes power or ground. The signals marked with * = Negative true logic.

Extended System Management

The Extended System Management interface, implemented by the Super I/O chip (W83627HG), provide additional signals and functions to further improve system management. One of these signals is an output signal called FAN_PMOUT that allows system fan control using a PWM (Pulse Width Modulation) Output. Additionally there is an input signal called FAN_TACHOIN that provides the ability to monitor the system fan's RPMs (revolutions per minute).

Table 3-14. Miscellaneous Interface Pin/Signal Descriptions (J2)

Pin #	Signal	Description
64	PCI_GNT#A	Reserved
66	PCI_REQ#A	Reserved
90	FAN_TACHOIN	Fan Tachometer Input – This signal provides the speed (or tachometer) input from the fan.
92	FAN_PWMOUT	Fan Speed Control Out – This output signal uses the Pulse Width Modulation (PWM) technique to control the fan's RPM.
48	WDTRIG	Watch Dog Trigger Input – This signal provides a watchdog (WDT) trigger signal to the system.
49	SLP_S3*	S3 (Suspend to RAM) Sleep Control – Signal shuts off power to all non-critical systems when in S3, S4, or S5 states
32	SUS_STAT*	Suspend Status – This signal indicates the system will be entering a low power state soon.
14, 20	5V_SB	+5 Volt Standby – Additional suspend voltage. If power supply does not provide standby voltage, connect this pin to VCC (+5V).
19, 51, 52, 74, 80, 83, 84	VCC	DC Power – +5VDC, ±5%
1, 2, 7, 8, 13, 26, 29, 35, 36, 42, 57, 67, 68, 73, 99, 100	GND	Ground
34, 60, 62, 65, 70, 72, 76, 78,	NC	Not connected (Reserved)

Notes: The shaded area denotes power or ground. The signals marked with * = Negative true logic.

Table 3-15. Complete J2 Interface Pin/Signal Descriptions (J2)

Pin #	Signal	Description
1, 2	GND	Ground
3	PCIE_CLK_REF+	PCI Express Reference Clock, Positive Differential Line
4	SATA0_RX+	Serial ATA Channel 0, Receive Input, Positive Differential Line
5	PCIE_CLK_REF-	PCI Express Reference Clock, Negative Differential Line
6	SATA0_RX-	Serial ATA Channel 0, Receive Input, Negative Differential Line
7, 8	GND	Ground
9	PCIE3_TX+	PCI Express Lane 3, Transmit Output, Positive Differential Line
10	SATA0_TX-	Serial ATA Channel 0, Transmit Output, Negative Differential Line
11	PCIE3_TX-	PCI Express Lane 3, Transmit Output, Negative Differential Line
12	SATA0_TX+	Serial ATA Channel 0, Transmit Output, Positive Differential Line
13	GND	Ground
14	5V_SB	+5 Volt Standby – Additional suspend voltage.
15	PCIE3_RX+	PCI Express Lane 3, Receive Input, Positive Differential Line
16	SATA1_RX+	Serial ATA Channel 1, Receive Input, Positive Differential Line

Pin #	Signal	Description
17	PCIE3_RX-	PCI Express Lane 3, Receive Input, Negative Differential Line
18	SATA1_RX-	Serial ATA Channel 1, Receive Input, Negative Differential Line
19	VCC	DC Power – +5 VDC, $\pm 5\%$
20	5V_SB	+5 Volt Standby – Additional suspend voltage.
21	EXC1_CPPE*	ExpressCard (capable card) Request Slot 2
22	SATA1_TX-	Serial ATA Channel 1, Transmit Output, Negative Differential Line
23	EXC1_RST#	ExpressCard Reset Slot 2
24	SATA1_TX+	Serial ATA Channel 1, Transmit Output, Positive Differential Line
25	USBP5+	Universal Serial Bus Port 5, Positive Differential Line
26	GND	Ground
27	USBP5-	Universal Serial Bus Port 5, Negative Differential Line
28	SATA2_RX+	Serial ATA Channel 2, Receive Input, Positive Differential Line
29	GND	Ground
30	SATA2_RX-	Serial ATA Channel 2, Receive Input, Negative Differential Line
31	PCIE2_TX+	PCI Express Lane 2, Transmit Output, Positive Differential Line
32	SUS_STAT*	Suspend Status
33	PCIE2_TX-	PCI Express Lane 2, Transmit Output, Negative Differential Line
34	NC	Not Connected - RESERVED
35, 36	GND	Ground
37	PCIE2_RX+	PCI Express Lane 2, Receive Input, Positive Differential Line
38	SATA2_TX-	Serial ATA Channel 2, Transmit Output, Negative Differential Line
39	PCIE2_RX-	PCI Express Lane 2, Receive Input, Negative Differential Line
40	SATA2_TX+	Serial ATA Channel 2, Transmit Output, Positive Differential Line
41	EXC0_CPPE*	ExpressCard (capable card) Request Slot 1
42	GND	Ground
43	EXC0_RST*	ExpressCard Reset Slot 1
44	SATA3_RX+	Serial ATA Channel 3, Receive Input, Positive Differential Line
45	USBP4+	Universal Serial Bus Port 4, Positive Differential Line
46	SATA3_RX-	Serial ATA Channel 3, Receive Input, Negative Differential Line
47	USBP4-	Universal Serial Bus Port 4, Negative Differential Line
48	WDTRIG	Watch Dog Trigger input
49	SLP_S3*	S3 (Suspend to RAM) Sleep Control
50	SATALED*	Serial ATA activity LED
51, 52	VCC	DC Power – +5 VDC, $\pm 5\%$
53	PCIE1_RX-	PCI Express Lane 1, Receive Input, Negative Differential Line
54	SATA3_TX-	Serial ATA Channel 3, Transmit Output, Negative Differential Line
55	PCIE1_RX+	PCI Express Lane 1, Receive Input, Positive Differential Line
56	SATA3_TX+	Serial ATA Channel 3, Transmit Output, Positive Differential Line
57	GND	Ground
58	IL_SATA*	Serial ATA Interlock Switch Input

Pin #	Signal	Description
59	PCIE1_TX-	PCI Express Lane 1, Transmit Output, Negative Differential Line
60	NC	Not Connected (Reserved)
61	PCIE1_TX+	PCI Express Lane 1, Transmit Output, Positive Differential Line
62	NC	Not Connected (Reserved)
63	PCE_WAKE*	PCI Express Wake Event
64	PCI_GNT#A	Reserved
65	NC	Not Connected (Reserved)
66	PCI_REQ#A	Reserved
67, 68	GND	Ground
69	PCIE0_RX-	PCI Express Lane 0, Receive Input, Negative Differential Line
70	NC	Not Connected (Reserved)
71	PCIE0_RX+	PCI Express Lane 0, Receive Input, Positive Differential Line
72	NC	Not Connected (Reserved)
73	GND	Ground
74	VCC	DC Power – +5 VDC, $\pm 5\%$
75	PCIE0_TX-	PCI Express Lane 0, Transmit Output, Negative Differential Line
76	NC	Not Connected (Reserved)
77	PCIE0_TX+	PCI Express Lane 0, Transmit Output, Positive Differential Line
78	NC	Not Connected (Reserved)
79	CODECSET	AC'97/HDA Disable onboard Audio CODEC
80	VCC	DC Power +5VDC, $\pm 5\%$
81	AC_RST*	AC'97/HDA CODEC Reset
82	AC_SDOUT	AC'97/HDA Audio Serial Data Output to CODEC
83, 84	VCC	DC Power – +5 VDC, $\pm 5\%$
85	AC_SYNC	AC'97/HDA Serial Bus Synchronization
86	AC_SDIN0	AC'97/HDA Audio Serial Data Input from CODEC0
87	AC_SDIN1	AC'97/HDA Audio Serial Data Input from CODEC1
88	AC_SDIN2	AC'97/HDA Audio Serial Data Input from CODEC2
89	AC_BIT_CLK	AC'97/HDA 12.228 MHz Serial Bit Clock from CODEC
90	FAN_TACHOIN	Fan tachometer input
91	LPC_AD0	LPC Multiplexed Command, Address and Data line 0
92	FAN_PWMOUT	Fan speed control
93	LPC_AD1	LPC Multiplexed Command, Address and Data line 1
94	LPC_FRAME*	LPC Frame – Indicates start of a new or termination of a broken cycle.
95	LPC_AD2	LPC Multiplexed Command, Address and Data line 2
96	LPC_DRQ0*	LPC Encoded DMA/Bus Master Request line 0
97	LPC_AD3	LPC Multiplexed Command, Address and Data line 3
98	LPC_DRQ1*	LPC Encoded DMA/Bus Master Request line 1
99	GND	Ground
100	GND	Ground

Notes: The shaded area denotes power or ground. The signals marked with * = Negative true logic.

Primary I/O Interface (J3)

The J3 connector has 100 pins and is used for Floppy or Printer port (LPT1), Serial ports (COM1 and COM2) Mouse and Keyboard interfaces, Infrared (IrDA) port, and the video interfaces for standard CRT video and LVDS ports.

Floppy Port

The floppy interface shares signal lines with the Parallel interface. The BIOS settings determine which one is operational. A standard 34-pin floppy drive connector is listed in Table 3-16 for reference along with the J3 connector pins. This type of connector can be located on the custom baseboard if desired.

- Supports only one floppy drive on floppy drive B
- 16 bytes of FIFO
- Data rate up to 1 Mbps

Table 3-16. Simplified Floppy Drive Interface Pin/Signal Descriptions (J3)

J3 Pin #	Signal	34-Pin Cable	Description
51	LPT/FLPY*	NC	Parallel/Floppy Select – This input signal selects the parallel or floppy port signal. If this signal is Low at boot time, the floppy drive is selected. If signal is High at boot time, the parallel port is selected. This state can not be changed until the next boot cycle.
56	DENSEL	2	Drive Density Select (Bit 0) – This signal indicates when a low (250/300kBps) or high (500/1kBps) data rate is selected.
NC	NC	4	NC
NC	KEY	6	Key – Not connected
80	INDEX*	8	Index – This signal indicates when head is positioned over the beginning of a track or index hole.
86	MOT1*	16	Motor Control 1 – Select motor on drive 1.
55	Reserved	14	Reserved (Drive Select 0)
84	DRV1*	12	Drive Select 1 – Select drive 1.
58	Reserved	10	Reserved (Motor Control 0)
64	DIR*	18	Direction – Direction of head movement (0 = inward motion, 1 = outward motion).
70	STEP*	20	Step – Low pulse for each track-to-track movement of the head.
88	WDATA*	22	Write Data – Encoded data to the drive for write operations.
90	WGATE*	24	Write Gate – Signal to the drive to enable current flow in the write head.
78	TRK0*	26	Track 0 – Sense detects the head is positioned over track 0.
76	WP*	28	Write Protect – Senses the diskette is write protected.
74	RDATA*	30	Read Data – Raw serial bit stream from the drive for read operations.
60	HDSEL*	32	Head Select – Selects the side for Read/Write operations (0 = side 1, 1 = side 0)
72	DSKCHG*	34	Disk Change – Senses the drive door is open or the diskette has been changed since the last drive selection.
66	GND	all odd	Ground (1-33)

Notes: The shaded area denotes power or ground. The signals marked with * indicate active low.

Parallel Port

Parallel port supports standard parallel, Bi-directional, ECP and EPP protocols. The Super I/O (W83627HG) chip provides the parallel port interface signals.

- The Parallel interface shares signal lines with the Floppy interface. The BIOS settings determine which one is operational.
- Supports Standard Printer Port (SPP), Enhanced Parallel Port (EPP) and Enhanced Capabilities Port (ECP)

A Standard Parallel port cable pin-out is listed in Table 3-17 for reference along with the J3 connector pins. A DB25 connector can be located on the custom baseboard if desired.

Table 3-17. Simplified Parallel Interface (SPP) Pin/Signal Descriptions (J3)

J3 Pin #	Signal	DB25 Pin #	Description
51	LPT/FLPY*	NC	Parallel/Floppy Select – This input signal selects the parallel or floppy port signal. If this signal is Low at boot time, the floppy drive is selected. If signal is High at boot time, the parallel port is selected. This state can not be changed until the next boot cycle.
55	Strobe*	1	Strobe* – This output signal is used to strobe data into the printer. I/O pin in ECP/EPP mode.
80	PD0	2	Parallel Port Data 0 – This signal (0 to 7) provides a parallel port data signal and is the LSB of printer data.
78	PD1	3	Parallel Port Data 1 – Refer to pin-2 and 9 for more information.
76	PD2	4	Parallel Port Data 2 – Refer to pin-2 and 9 for more information.
74	PD3	5	Parallel Port Data 3 – Refer to pin-2 and 9 for more information.
72	PD4	6	Parallel Port Data 4 – Refer to pin-2 and 9 for more information.
68	PD5	7	Parallel Port Data 5 – Refer to pin-2 and 9 for more information.
62	PD6	8	Parallel Port Data 6 – Refer to pin-2 and 9 for more information.
58	PD7	9	Parallel Port Data 7 – This signal provides a parallel port data signal and is the MSB of printer data.
84	ACK*	10	Acknowledge * – This is a status input signal from the printer. A Low State indicates it has received the data and is ready to accept new data.
86	BUSY	11	Busy – This is a status input signal from the printer. A high state indicates the printer is not ready to accept data.
88	PE	12	Paper End – This is a status input signal from the printer. A high state indicates it is out of paper.
90	SLCT	13	Select – This is a status output signal from the printer. A high state indicates it is selected and powered on.
56	AFD*	14	Auto Feed * – This is a output signal from the printer to automatically feed one line after each line is printed.
60	ERR*	15	Error – This is a status output signal from the printer. A low state indicates an error condition on the printer.
64	INIT*	16	Initialize * – This signal initializes the printer. Output in standard mode, I/O in ECP/EPP mode.
70	SLCTIN	17	Select In – This output signal is used to select the printer. I/O pin in ECP/EPP mode.
66	GND	18-25	Ground

Notes: The shaded area denotes power or ground. The signals marked with * indicate active low.

Serial Ports 1 and 2

The Super I/O (W83627HG) provides the circuitry for two serial ports with TTL compatible. Serial ports 1 (COM1) and 2 (COM2) are provided to the baseboard through connector J3. The serial port features are:

- Two individual 16550-compatible UARTs
- Programmable word length, stop bits and parity
- 16-bit programmable baud rate generator
- Loop-back mode
- Two individual 16-bit FIFOs

The standard serial DB9 cable pin-outs are listed in Table 3-18 for reference along with the J3 connector pins. DB9 connectors can be located on the custom baseboard, as application requires.

Table 3-18. Simplified Serial Interface Pin/Signal Descriptions (J3)

J3 Pin #	Pin # DB9	Signal	Description
89	1 (COM1)	DCD1*	Data Carrier Detect 1 – Indicates external serial device is detecting a carrier signal (i.e., a communication channel is currently open). In direct connect environments, this input is driven by DTR1 as part of the DTR1/DSR1 handshake.
91	6	DSR1*	Data Set Ready 1 – Indicates external serial device is powered, initialized, and ready. Used as hardware handshake with DTR1 for overall readiness.
83	2	RXD1	Receive Data 1 – Serial port 1 receive data in.
85	7	RTS1*	Request To Send 1 – Indicates Serial port 1 is ready to transmit data. Used as hardware handshake with CTS1 for low level flow control.
95	3	TXD1	Transmit Data 1 – Serial port 1 transmit data out
93	8	CTS1*	Clear To Send 1 – Indicates external serial device is ready to receive data. Used as hardware handshake with RTS1 for low level flow control.
87	4	DTR1*	Data Terminal Ready 1 – Indicates Serial port 1 is powered, initialized, and ready. Used as hardware handshake with DSR1 for overall readiness.
97	9	RI1*	Ring Indicator 1 – Indicates external serial device is detecting a ring condition. Used by software to initiate operations to answer and open the communications channel.
	5	GND	Ground
10	NC	KEY/NC	Key/Not connected
71	1 (COM2)	DCD2*	Data Carrier Detect 2 – Indicates external serial device is detecting a carrier signal (i.e., a communication channel is currently open). In direct connect environments, this input is driven by DTR2 as part of the DTR2/DSR2 handshake.
73	6	DSR2*	Data Set Ready 2 – Indicates external serial device is powered, initialized, and ready. Used as hardware handshake with DTR2 for overall readiness.
63	2	RXD2	Receive Data 2 – Serial port 2 receive data in
67	7	RTS2*	Request To Send 2 – Indicates Serial port 2 is ready to transmit data. Used as hardware handshake with CTS2 for low level flow control.
77	3	TXD2	Transmit Data 2 – Serial port 2 transmit data out

J3 Pin #	Pin # DB9	Signal	Description
75	8	CTS2*	Clear To Send 2 – Indicates external serial device is ready to receive data. Used as hardware handshake with RTS2 for low level flow control.
69	4	DTR2*	Data Terminal Ready 2 – Indicates Serial port 1 is powered, initialized, and ready. Used as hardware handshake with DSR2 for overall readiness.
79	9	RI2*	Ring Indicator 2 – Indicates external serial device is detecting a ring condition. Used by software to initiate operations to answer and open the communications channel.
19	5	GND	Ground
20	NC	NC	Not connected

Notes: The shaded area denotes power or ground. The signals marked with * = Negative true logic.

Infrared (IrDA) Port

The Infrared Data Association (IrDA) port provides a two-way wireless communications port using infrared as a transmission medium at the basic level. There are two basic infrared implementations provided; the Hewlett-Packard Serial Infrared (HPSIR) and the Amplitude Shift Keyed Infrared (ASKIR) methods. HPSIR is a serial implementation of infrared developed by Hewlett-Packard. The IrDA (HPSIR and ASKIR) signals share Serial Port 2 with the modem and RS232 functions on the port. This port can be enabled/disabled and configured for HPSIR or ASKIR signals in the BIOS Setup Utility. Refer to Chapter 4, *BIOS Setup Utility* for more information.

The HPSIR method allows serial communication at baud rates up to 115k baud. Each word is sent serially beginning with a zero value start bit. A zero is sent when a single infrared pulse is sent at the beginning of the serial bit time. A one is sent when no infrared pulse is sent during the bit time.

The Amplitude Shift Keyed infrared (ASKIR) allows serial communication at baud rates up to 19.2k baud. Each word is sent serially beginning with a zero value start bit. A zero is sent when a 500 kHz waveform is sent for the duration of the serial bit time. A one is sent when no transmission is sent during the serial bit time.

Both of these methods require an understanding of the timing diagrams provided in the Super I/O controller chip (W83627HG) specifications available from the manufacture's web site and referenced earlier in this manual. For more information, refer to the Winbond Electronics, Corp. chip specifications and the Infrared Data Association web site at <http://www.irda.org>.

NOTE	For infrared applications not covered in this brief description, refer to the 83627HG chip specifications by Winbond Electronics, Corp.
-------------	---

PS/2 Keyboard

The signal lines for a PS/2 keyboard are provided through the J3 connector from the Super I/O (W83627HG). Refer to Table 3-19 for the Simplified PS/2 Keyboard Pin/Signal Descriptions.

PS/2 Mouse

The signal lines for a PS/2 mouse are provided through the J3 connector from the Super I/O (W83627HG). Refer to Table 3-19 for the Simplified PS/2 Mouse Pin/Signal Descriptions.

Table 3-19. Simplified Keyboard, Mouse, and Infrared (IrDA) Port Pin/Signal Descriptions (J3)

J3 Pin #	Signal	Description
98	KBDAT	Keyboard Data – This signal provides the keyboard data.
96	KBCLK	Keyboard Clock – This signal provides the clocks to the keyboard.
94	MSDAT	Mouse Data – This signal provides the mouse data.
92	MSCLK	Mouse Clock – This signal clocks the data from the mouse.
	GND	Signal Ground
61	IRTX	IR Transmit Data (HPSIR or ASKIR)
59	IRRX	IR Receive Data (HPSIR or ASKIR)

Note: The shaded area denotes power or ground.

Video Interface

The Memory & Graphics Hub (Northbridge) chip (82915GM) provides the integrated video controller for the CRT, LVDS, SDVO, and TV Out ports. The 82915GM video chip features are listed here and with the specific video port on the following pages.

- ◆ See Table 3-20 for the CRT information.
- ◆ See Table 3-21 for the LVDS information.
- ◆ See Table 3-23 for the TV Out information.
- ◆ See Table 3-29 for the SDVO information.

Internal Graphics Features

- Supports up to 128 MB of system memory dynamically allocated by Dynamic Video Memory Technology (DVMT) 3.0
- Provides Intel® Dual-Frequency Graphics Technology
- Provides Intel® Smart 2D Display Technology
- Provides High Quality 3D Setup and Render Engine
- Provides High Quality Texture Engine
- Supports Dual Independent display pipes

Video Engine

- Supports Hardware Motion Compensation for MPEG2
- Provides Sub-Picture and De-interlacing support
- Provides Dynamic Bob and Weave support
- Provides Video Overlay support

CRT Interface

The CRT interface supports the following features:

- Supports maximum DAC frequency up to 400 MHz
- Supports 8-bits for each RGB DAC or 24-bit RAMDAC
- Supports up to 2048 x 1536 @ 75Hz (QXGA) and 1920 x 1080 @ 85Hz for HDTV
- Supports DDC2B compliance

Refer to Table 3-20 for the Simplified CRT Interface Pin/Signal Descriptions.

Table 3-20. Simplified CRT Interface Pin/Signal Descriptions (J3)

J3 Pin #	Signal	VGA 15-Pin #	Description
3	RED	1	Red – This is the Red analog output signal to the CRT.
6	GREEN	2	Green – This is the Green analog output signal to the CRT.
4	BLUE	3	Blue – This is the Blue analog output signal to the CRT.
NC	NC	4	Not Connected
	GND	5, 6, 7, 8, 10	Ground
NC	NC	9	Not Connected
	NC	11	Not Connected
10	DDDA	12	Display Data Channel Data – This signal line provides information to the Memory & Graphics Hub about the monitor type, brand, model. This is part of the Plug and Play standard developed by the VESA trade association.
5	HSYNC	13	Horizontal Sync – This signal is used for the digital horizontal sync output to the CRT.
7	VSYNC	14	Vertical Sync – This signal is used for the digital vertical sync output to the CRT.
8	DDCK	15	Display Data Channel Clock – This signal line provides the data clock signal to the Memory & Graphics Hub from the monitor. This is part of the Plug and Play standard developed by the VESA trade association.

Note: The shaded area denotes power or ground.

LVDS Interface

The LVDS interface is dedicated and independent of the other video interfaces and provides the following features:.

- Supports ANSI/TIA/EIA-644-2001 specification compliance
- Supports 25 to 112 MHz single/dual channel LVDS interface with Spread Spectrum Clocking (SSC)

NOTE	Spread Spectrum Clocking is controlled in BIOS Setup under the Advanced menu. Refer to Chapter 4, <i>BIOS Setup</i> for the Clock Configuration where you can set the Spread Spectrum Clock.
-------------	--

- Supports maximum TFT pixel format of 1x18 bpp for one channel and 2x18 bpp for 2 channels
- Supports flat panel size up to UXGA (1600 x 1200)
- Supports Wide panel size up to WUXGA (1920 x 1200)
- Provides Automatic Panel Detection using EPI (Embedded Panel Interface based on VESA EDID™ 1.3)
- Supports Intel® Display Power Savings Technology 2.0

Refer to Table 3-21 for the Simplified LVDS Interface Pin/Signal Descriptions.

Table 3-21. Simplified LVDS Interface Pin/Signal Descriptions (J3)

J3 Pin #	Signal	Description
39, 40	VCC	DC Power – +5V +/- 5%
	GND	Ground
37	LCDD00	LVDS Channel Data Line 0
35	LCDD01	LVDS Channel Data Line 1
38	LCDD02	LVDS Channel Data Line 2
36	LCDD03	LVDS Channel Data Line 3
29	LCDD04	LVDS Channel Data Line 4
31	LCDD05	LVDS Channel Data Line 5
32	LCDD06	LVDS Channel Data Line 6
30	LCDD07	LVDS Channel Data Line 7
23	NS	Not Supported (LCDD08)
25	NS	Not Supported (LCDD09)
26	LCDD10	LVDS Channel Data Line 10
24	LCDD11	LVDS Channel Data Line 11
19	LCDD12	LVDS Channel Data Line 12
17	LCDD13	LVDS Channel Data Line 13
20	LCDD14	LVDS Channel Data Line 14
18	LCDD15	LVDS Channel Data Line 15
11	LCDD16	LVDS Channel Data Line 16
13	LCDD17	LVDS Channel Data Line 17
12	NS	Not Supported (LCDD18)
14	NS	Not Supported (LCDD19)
41	FPDDC_DAT	Flat Panel I ² C Data – I ² C data interface to flat panel parameter EEPROM.
43	FPDDC_CLK	Flat Panel I ² C Clock – I ² C clock interface to flat panel parameter EEPROM.
44	BLON*	Backlight On – Control signal for external flat panel backlight power.
45	BIASON	BIAS ON – Flat panel contrast voltage control.
46	DIGON	Digital Power On – Controls digital flat panel power on.
9	NC	Not Connected (DETECT* = Panel hot-plug detection)

Notes: The shaded area denotes power or ground. NS = Not supported

TV Out (Component and S-Video)

The TV interface provides an integrated TV encoder with the following features:

- Supports Composite and S-Video up to 1024 x 768 resolution for NTSC/PAL
- Supports Component Video in 480p/720p/1080i/1080p modes

Table 3-22. Simplified TV Out (S-Video) Interface Pin/Signal Descriptions (J3)

Pin #	Signal	Description
	GND	Ground
47	Comp	Composite Analog Output – Composite Video output, or RGB Blue video (SCART).
48	Y	Y Analog S-Video Output – Y (Luminance) output for S-Video
49	NC	Not Connected (Composite Sync)
50	C	C Analog S-Video Output – C (Color/Chrominance) output for S-Video.

Note: The shaded area denotes power or ground.

Table 3-23. Complete J3 Interface Pin/Signal Descriptions (J3)

Pin #	Signal	Description
1, 2	GND	Ground
3	Red	Red – This is the Red analog output signal to the CRT.
4	Blue	Blue – This is the Blue analog output signal to the CRT.
5	HSYNC	Horizontal Sync – This is the digital horizontal sync output signal to the CRT.
6	Green	Green – This is the Green analog output signal to the CRT.
7	VSYNC	Vertical Sync – This is the digital vertical sync output signal to the CRT.
8	DDCK	Display Data Channel Clock – This signal line provides the data clock signal to the Memory & Graphics Hub from the monitor. This is part of the Plug and Play standard developed by the VESA trade association.
9	NC	Not Connected (DETECT* = Panel hot-plug detection)
10	DDDA	Display Data Channel Data – This signal line provides information to the Memory & Graphics Hub about the monitor type, brand, model. This is part of the Plug & Play standard developed by the VESA trade association.
11	LCDD16	LVDS Channel Data Line 16
12	NS	Not supported (LCDD18)
13	LCDD17	LVDS Channel Data Line 17
14	NS	Not supported (LCDD19)
15, 16	GND	Ground
17	LCDD13	LVDS Channel Data Line 13
18	LCDD15	LVDS Channel Data Line 15
19	LCDD12	LVDS Channel Data Line 12
20	LCDD14	LVDS Channel Data Line 14
21, 22	GND	Ground
23	NS	Not supported (LCDD8)
24	LCDD11	LVDS Channel Data Line 11
25	NS	Not supported (LCDD9)

Pin #	Signal	Description
26	LCDD10	LVDS Channel Data Line 10
27, 28	GND	Ground
29	LCDD04	LVDS Channel Data Line 4
30	LCDD07	LVDS Channel Data Line 7
31	LCDD05	LVDS Channel Data Line 5
32	LCDD06	LVDS Channel Data Line 6
33, 34	GND	Ground
35	LCDD01	LVDS Channel Data Line 1
36	LCDD03	LVDS Channel Data Line 3
37	LCDD00	LVDS Channel Data Line 0
38	LCDD02	LVDS Channel Data Line 2
39, 40	VCC	DC Power – +5V +/- 5%
41	FPDDC_DAT	Flat Panel I ² C Data – I ² C data interface to flat panel parameter EEPROM.
42	NC	Not connected (LTGIO)
43	FPDDC_CLK	Flat Panel I ² C Clock – I ² C clock interface to flat panel parameter EEPROM.
44	BLON*	Backlight On – Control signal for external flat panel backlight power.
45	NC	Not connected (BIASON)
46	DIGON	Digital Power On – This signal controls the digital flat panel power up.
47	COMP	Composite Analog Output
48	Y	TV Luminance for S-Video
49	NC	Not Connected (Composite Sync)
50	C	TV Chrominance for S-Video
51	LPT/FLPY*	Parallel/Floppy Select – This input signal selects the parallel or floppy port signal. If this signal is Low at boot time, the floppy drive is selected. If this signal is High at boot time, the parallel port is selected. This state can not be changed until the next boot cycle.
52	NC	Not Connected (Reserved)
53	VCC	DC Power – +5V +/- 5%
54	GND	Ground
55	Strobe*	Parallel Strobe* – This output signal is used to strobe data into the printer. I/O pin in ECP/EPP mode.
56	AFD* DENSEL	Parallel Auto Feed * – This is a output signal from the printer to automatically feed one line after each line is printed. Floppy Drive Density Select – This signal indicates if a low (250/300kBps) or high (500/1kBps) data rate is selected.
57	NC	Not Connected (Reserved)
58	PD7	Parallel Port Data 7 – This signal (0 to 7) provides a parallel port data signal and is the printer data MSB.
59	IRRX	IR Receive Data (HPSIR or ASKIR)

Pin #	Signal	Description
60	ERR* HDSEL*	Parallel Error – This is a status output signal from the printer. A low state indicates an error condition on the printer. Floppy Head Select – Selects the side for Read/Write operations (0 = side 1, 1 = side 0)
61	IRTX	IR Transmit Data (HPSIR or ASKIR)
62	PD6	Parallel Port Data 6 – This signal (0 to 7) provides a parallel port data signal and is the printer data MSB.
63	RXD2	Receive Data 2 – Serial port 2 receive data in.
64	INIT* DIR*	Parallel Initialize* – This signal initializes the printer. Output in standard mode, I/O in ECP/EPP mode. Floppy Direction – Direction of head movement (0 = inward motion, 1 = outward motion).
65, 66	GND	Ground
67	RTS2*	Request To Send 2 – Indicates Serial port 2 is ready to transmit data. Used as hardware handshake with CTS2 for low level flow control.
68	PD5	Parallel Port Data 5 – Refer to pin-58 and 80 for more information.
69	DTR2*	Data Terminal Ready 2 – Indicates Serial port 1 is powered, initialized, and ready. Used as hardware handshake with DSR2 for overall readiness.
70	SLCTIN* STEP*	Select In – This output signal is used to select the printer. I/O pin in ECP/EPP mode. Floppy Step – Low pulse for each track-to-track movement of the head.
71	DCD2*	Data Carrier Detect 2 – Indicates external serial device is detecting a carrier signal (i.e., a communication channel is currently open). In direct connect environments, this input is driven by DTR2 as part of the DTR2/DSR2 handshake.
72	PD4 DSKCHG*	Parallel Port Data 4 – Refer to pin-58 and 80 for more information. Floppy Disk Change – Senses the drive door is open or the diskette has been changed since the last drive selection.
73	DSR2*	Data Set Ready 2 – Indicates external serial device is powered, initialized, and ready. Used as hardware handshake with DTR2 for overall readiness.
74	PD3 RDATA*	Parallel Port Data 3 – Refer to pin-58 and 80 for more information. Floppy Read Data – Raw serial bit stream from drive for read operations.
75	CTS2*	Clear To Send 2 – Indicates external serial device is ready to receive data. Used as hardware handshake with RTS2 for low level flow control.
76	PD2 WP*	Parallel Port Data 2 – Refer to pin-58 and 80 for more information. Floppy Write Protect – Senses the diskette is write protected.
77	TXD2	Transmit Data 2 – Serial port 2 transmit data out
78	PD1 TRK0*	Parallel Port Data 1 – Refer to pin-58 and 80 for more information. Floppy Track 0 – Sense detects the head is positioned over track 0.
79	RI2*	Ring Indicator 2 – Indicates external serial device is detecting a ring condition. Used by software to initiate operations to answer and open the communications channel.

Pin #	Signal	Description
80	PD0 INDEX*	Parallel Port Data 0 – This pin (0 to 7) provides a parallel port data signal and is the printer data LSB. Floppy Index – Detects when the head is positioned over the beginning of the track.
81, 82	VCC	DC Power – +5V +/- 5%
83	RXD1	Receive Data 1 – Serial port 1 receive data in.
84	ACK* DRV*	Parallel Acknowledge * – This is a status input signal from the printer. A Low State indicates it has received the data and is ready to accept new data. Floppy Drive Select 1 – This signal selects drive 1.
85	RTS1*	Request To Send 1 – Indicates Serial port 1 is ready to transmit data. Used as hardware handshake with CTS1 for low level flow control.
86	BUSY MOT*	Parallel Busy – This is a status input signal from the printer. A high state indicates the printer is not ready to accept data. Floppy Motor Control 1 – This signal selects motor on drive 1.
87	DTR1*	Data Terminal Ready 1 – Indicates Serial port 1 is powered, initialized, and ready. Used as hardware handshake with DSR1 for overall readiness.
88	PE WDATA*	Parallel Paper End – This is a status input signal from the printer. A high state indicates it is out of paper. Floppy Write Data – Encoded data to the drive for write operations.
89	DCD1*	Data Carrier Detect 1 – Indicates external serial device is detecting a carrier signal (i.e., a communication channel is currently open). In direct connect environments, this input is driven by DTR1 as part of the DTR1/DSR1 handshake.
90	SLCT* WGATE*	Parallel Select – This is a status output signal from the printer. A high state indicates it is selected and powered on. Floppy Write Gate – Signals drive to enable current flow in the write head.
91	DSR1*	Data Set Ready 1 – Indicates external serial device is powered, initialized, and ready. Used as hardware handshake with DTR1 for overall readiness.
92	MSCLK	Mouse Clock – This signal clocks the data from the mouse.
93	CTS1*	Clear To Send 1 – Indicates external serial device is ready to receive data. Used as hardware handshake with RTS1 for low level flow control.
94	MSDAT	Mouse Data – This signal provides the mouse data.
95	TXD1	Transmit Data 1 – Serial port 1 transmit data out
96	KBCLK	Keyboard Clock – This signal clocks the data from the keyboard.
97	RI1*	Ring Indicator 1 – Indicates external serial device is detecting a ring condition. Used by software to initiate operations to answer and open the communications channel.
98	KBDAT	Keyboard Data – This signal provides the keyboard data
99	GND	Ground
100	GND	Ground

Notes: The shaded area denotes power or ground. The signals marked with * = Negative true logic.

IDE and Auxiliary Interface (J4)

The J4 connector has 100 pins and is used for Primary IDE, Secondary IDE, Ethernet port, RTC/Battery, speaker, power management, SMBus, and power management interfaces.

IDE Ports

- Supports one Primary EIDE channel (Secondary IDE channel not connected)
- Supports EIDE Ultra DMA 33/66/100 in Master Mode
- Master mode PCI supporting EIDE devices
- Supports ATAPI compliant devices including DVD devices
- PIO IDE transfers up to 14 Mbytes/sec
- Bus Master IDE transfers up to 100 Mbps

The standard 40-pin cable pin-outs are listed in Table 3-24 for J3 connector pin reference. The single Primary channel can be routed to the IDE connector on the custom baseboard per the application requirements.

Table 3-24. Simplified Primary IDE Interface Pin/Signal Descriptions (J4)

J4 Pin #	Signal	40-Pin #	Description
98	HDRST*	1	Hard Reset – Low active hardware reset (RSTDRV inverted)
	GND	2	Ground
96	PIDE_D7	3	Disk Data – These signals (0 to 15) provide the disk data signals
92	PIDE_D8	4	Disk Data 8 – Refer to D7, pin-3, for more information.
88	PIDE_D6	5	Disk Data 6 – Refer to D7, pin-3, for more information.
86	PIDE_D9	6	Disk Data 9 – Refer to D7, pin-3, for more information.
84	PIDE_D5	7	Disk Data 5 – Refer to D7, pin-3, for more information.
80	PIDE_D10	8	Disk Data 10 – Refer to D7, pin-3, for more information.
78	PIDE_D4	9	Disk Data 4 – Refer to D7, pin-3, for more information.
76	PIDE_D11	10	Disk Data 11 – Refer to D7, pin-3, for more information.
74	PIDE_D3	11	Disk Data 3 – Refer to D7, pin-3, for more information.
72	PIDE_D12	12	Disk Data 12 – Refer to D7, pin-3, for more information.
70	PIDE_D2	13	Disk Data 2 – Refer to D7, pin-3, for more information.
68	PIDE_D13	14	Disk Data 13 – Refer to D7, pin-3, for more information.
64	PIDE_D1	15	Disk Data 1 – Refer to D7, pin-3, for more information.
62	PIDE_D14	16	Disk Data 14 – Refer to D7, pin-3, for more information.
60	PIDE_D0	17	Disk Data 0 – Refer to D7, pin-3, for more information.
58	PIDE_D15	18	Disk Data 15 – Refer to D7, pin-3, for more information.
	GND	19	Ground
NC	Key	20	Key pin plug
56	PIDE_DRQ	21	DMA Request – Used for DMA transfers between host and drive (direction of transfer controlled by IOR* and IOW*). Also used in an asynchronous mode with ACK*. Drive asserts an IRQ when ready to transfer or receive data.

J4 Pin #	Signal	40-Pin #	Description
	GND	22	Ground
54	PIDE_IOW*	23	Drive I/O Write – Strobe signal for write functions. Negative edge enables data from a register or data port of the drive onto the host data bus. Positive edge latches data at the host.
	GND	24	Ground
52	PIDE_IOR*	25	Drive I/O Read – Strobe signal for read functions. Negative edge enables data from a register or data port of the drive onto the host data bus. Positive edge latches data at the host.
	GND	26	Ground
48	PIDE_RDY	27	I/O Channel Ready – When negated extends the host transfer cycle of any host register access when the drive is not ready to respond to a data transfer request. High impedance if asserted.
90	CBLID_P*	28	Cable ID Select – Used to detect the presence of an 80 conductor IDE cable on the primary IDE channel. This allows BIOS or system software to determine if it is necessary to enable high-speed transfer modes (DMA66 or DMA100).
46	PIDE_AK*	29	DMA Channel Acknowledge – Used by the host to acknowledge data has been accepted or data is available. Used in response to DMARQ asserted.
	GND	30	Ground
44	PIDE_INTRQ	31	Drive Interrupt Request (IRQ 14)– Asserted by drive when it has pending interrupt (PIO transfer of data to or from the drive to the host).
NC	NC	32	Not Connected
40	PIDE_A1	33	Drive Address Bus 1 – Used (0 to 2) to indicate which byte in the ATA command block or control block (register) is being accessed.
NC	PDIAG*	34	Not Connected (Passed Diagnostics)
38	PIDE_A0	35	Drive Address Bus 0 – Used (0 to 2) to indicate which byte in the ATA command block or control block (register) is being accessed.
36	PIDE_A2	36	Drive Address Bus 2 – Used (0 to 2) to indicate which byte in the ATA command block or control block (register) is being accessed.
32	PIDE_CS1*	37	Chip Select 1 – Used to select the host-accessible Command Block Register.
30	PIDE_CS3*	38	Chip Select 3 – Used to select the host-accessible Command Block Register.
NC	DASP*	39	Not Connected (Drive Active/Drive Present)
	GND	40	Ground

Notes: The shaded area denotes power or ground. The signals marked with * = Negative true logic.

Ethernet Port Interface

The Ethernet solution is provided by integrating the functions of I/O Hub (82801FBM) and the Intel 82562GZ Fast Ethernet PCI controller chip together. The Intel 82562GZ chip provides the physical layer (PHY) and the I/O Hub provides the Media Access Controller (MAC).

- Routed to J4 connector
- Supports full duplex or half-duplex operation
- Supports full duplex operation at 10 Mbps and 100 Mbps
- Provides IEEE 802.3 10BaseT/100BaseT compatible physical layer and LAN connect interface
- Supports IEEE 802.3u Auto-Negotiation
- Supports IEEE 802.3x 100BASE-TX flow control
- Provides 10Base-T auto-polarity correction
- Provides PHY detection of polarity, MDI-X, and cable lengths
- Supports Auto MDI, MDIX crossover at all speeds
- Provides Digital Adaptive Equalization control
- Provides Link Status interrupt capability and XOR tree mode support
- Supports 3-port LEDs (speed, link, and activity)
- Supports diagnostic loopback mode
- Provides low power at 3.3 V (less than 300 mW in active transmit mode)
- Reduced power in "unplugged mode" (less than 50 mW)
- Provides automatic detection of "unplugged mode"
- Baseboard must provide the Ethernet RJ-45 connector and the magnetics

Table 3-25. Simplified Ethernet Port Pin/Signal Descriptions (J4)

J4 Pin #	Signal	Description
97	TX+	Analog Twisted Pair Ethernet Transmit Differential Pair – These pins transmit the serial bit stream to the baseboard as differential signals.
95	TX-	
93	RX	Analog Twisted Pair Ethernet Receive Differential Pair – These pins receive the serial bit stream from the baseboard as differential signals.
91	RX-	
	GND	Ground
10	LILED	Link Integrity LED – The LINK LED pin indicates link integrity. If the link is valid in either 10 or 100 Mbps, the LED is on; if the link is invalid, the LED is off.
12	ACTLED	Activity LED – The Activity LED pin indicates either transmit or receive activity. When activity is present, the activity LED is on; when no activity is present, the activity LED is off.
14	SPDLED	Speed LED – The speed LED pin indicates the speed. The speed LED will be on at 100 Mbps and off at 10 Mbps.

Note: The shaded area denotes power or ground.

Power Control Signals

The XTX 820 supports various power control signals provided by the baseboard to control the XTX module. These signals are listed here and in Tables 3-26 and 3-23.

- The Power Good input signal (PWGIN) is provided from an external input typically from the external power supply (ATX) to the baseboard. This signal is typically an active-high input to the XTX board and indicates to the XTX board it can begin the boot process. This Power Good signal can also be used as an active-low reset input to the XTX module.
- The Power Suspend signal (5V_SB) must be provided by a power supply capable of standby operation, typically an ATX power supply. The power supply must provide a 5 volt 100 ma stand-by power source for this function to be available.
- The Power On signal (PS_ON) is provided by the XTX module to the PS_ON input of an ATX power supply allowing it to switch to the main output power from a standby state. This signal is used in conjunction with the 5V_SB supplied to the XTX module from the ATX power supply.
- The Power Button Input signal (PWRBTN*) provides a ground temporarily through a momentary-contact switch or through an open collector driver to the ATX power supply. This signal is used in conjunction with the PS_ON and the 5V_SB signals from the ATX power supply to activate the power control button function of the power supply.
- A voltage monitor on the XTX 820 tracks the VCC voltage (+5 volts) state by monitoring the +3.3V generated on the XTX module. When the +3.3V drops below 3.0V or the Reset Button signal goes low, the voltage monitor sends a reset pulse to the Memory & Graphics Hub (Northbridge) chip (82915GM), the I/O Hub (Southbridge) chip (82801FBM), Super I/O (W83627HG) chip and the CPU.

Power Management Signals

The XTX 820 supports various power management signals listed below and in Tables 3-20 and 3-22.

- The External System Management Interrupt (EXTSMI) signal is routed to the baseboard through J4 to allow external circuitry to initiate an SMI for the EXT module.
- The Resume Reset input (RSMRST*) signal to the EXT module may be driven low by external control circuitry to reset the power management logic on the XTX module.
- The System Management Bus Alert input (SMBALRT*) signal is used by SMBus devices to indicate an event on the SMBus to the EXT module.
- The Battery Low input (BATLOW*) signal is used by external voltage monitoring circuitry to indicate to the XTX module that the system battery is low.

NOTE	Refer also to the additional Power Management Signals on J2.
-------------	--

Speaker

The signal lines for a speaker port with 0.1-watt drive are provided through J4 connector to the baseboard where the speaker may be located.

- The Super I/O (83627HG) provides the speaker output signal, but the output driver circuit must be implemented on the baseboard

Real Time Clock (RTC)/Battery

The XTX 820 supports a Real Time Clock (RTC) and CMOS RAM for the BIOS Setup Utility. The RTC and 256 byte of CMOS RAM are included inside the I/O Hub (Southbridge) chip (82801FBM). The RTC and CMOS are powered through pin-8 (BAT) on J4 with a Lithium Battery located on the baseboard. If the battery is not present, the BIOS has a battery-free boot option to complete the boot process. .

Table 3-26. Simplified Power Control and Miscellaneous Pin/Signal Descriptions (J4)

J4 Pin #	Signal	Description
3	5V_SB	5 volt Suspend – This control signal is sent to the ATX power supply for a suspend or standby state.
4	PWGIN	Power Good In – This active high input signal indicates to the XTX 820, the power is good and it can begin the boot process.
5	PS_ON	Power Supply On – This active-low output signal from the XTX 820 is sent to the ATX power supply to turn it on.
7	PWRBTN*	Power Button – This signal provides a ground temporarily through an open collector driver to the ATX power supply to change states (turn it on).
6	SPEAKER	Speaker – This PC speaker output signal must be connected to a speaker (piezoelectric or dynamic) on the baseboard to hear the output (beeps).
11	RSMRST*	Resume Reset – This signal is driven low by external circuitry to reset the power management logic on the XTX 820.
19	OVCR	Over Current Detect – This signal indicates a USB over-current condition.
8	BAT	Battery Voltage – This is the + battery connection to baseboard for +3 volt lithium backup battery used for RTC operation and CMOS non-volatile memory.
41	BATLOW*	Battery Low – This external signal to the XTX 820 indicates when the external battery is low.
21	EXTSMI*	Extern System Management Interrupt – This signal is provided by external circuitry to initiate an SMI event with the XTX 820.
23	SMBCLK	System Management Bus Clock – This signal is used to support internal and external SMBus devices, such as temperature and battery monitoring.
24	SMBDATA	System Management Bus Data – This signal is used to support internal and external SMBus devices, such as temperature and battery monitoring.
26	SMBALRT*	System Management Bus Alert – This signal is used by SMBus devices to signal an event on the SM Bus.

Note: The shaded area denotes power or ground.

SMBus (I²C Bus)

The I/O Hub (82801FBM) contains an integrated SMBus controller with both a host and slave SMBus port; but the host cannot access the slave internally. The slave port allows an external master access to the I/O Hub (Southbridge) through the J4 connector. The master contained in the I/O Hub is used to communicate with the Memory & Graphics Hub, DDR2 RAM EPROM, and the clock generator.

- The I²C slave address must not be the same as the I²C device on the baseboard.

Table 3-27. SMBus Reserved Addresses

Matrix Component	Address Binary
Memory & Graphics Hub (82915GM)	1010,010 _{x_b}
DDR2 RAM EPROM	1010,000 _{x_b}
Clock Generator (UICS954201)	1101,001 _{x_b}
I/O Hub (82801FBM)	0000,000 _{x_b} (default) Programmable

Table 3-28. Complete J4 Interface Pin/Signal Descriptions (J4)

Pin #	Signal	Description
1	GND1	Ground
2	GND3	Ground
3	5V_SB	5 volt Suspend – This control signal is sent to the ATX power supply for a suspended or standby state.
4	PWGIN	Power Good In – This active high input signal indicates to the XTX 820, the power is good and it can begin the boot process.
5	PS_ON	Power Supply On – This active-low output signal from the XTX 820 is sent to the ATX power supply from the to turn it on.
6	SPEAKER	Speaker – This PC speaker output signal must be connected to a speaker (piezoelectric or dynamic) on the baseboard to hear the output (beeps).
7	PWRBTN*	Power Button – This signal provides a ground temporarily through an open collector driver to the ATX power supply to change states (turn it on).
8	BATT	Battery Voltage – This is the + battery connection to the baseboard for +3 volt lithium backup battery used to power RTC operation and CMOS non-volatile memory.
9	KBINH	Keyboard Inhibit – This pin disables data input from the keyboard when asserted.
10	LILED	Link Integrity LED – The LINK LED pin indicates link integrity. If the link is valid in either 10 or 100 Mbps, the LED is on; if the link is invalid, the LED is off.
11	RSMRST*	Resume Reset – This signal is driven low by external circuitry to reset the power management logic on the XTX 820.
12	ACTLED	Activity LED – The Activity LED pin indicates either transmit or receive activity. When activity is present, the activity LED is on; when no activity is present, the activity LED is off.
13	NC	Not Connected (ROMKBCS*)
14	SPDLED	Speed LED – The speed LED pin indicates the speed. The speed LED will be on at 100 Mbps and off at 10 Mbps.
15	EXT_PRG	External Programming – This pin is used when handling external flash programming.
16	I ² CLK	I ² C Clock – This clock line supports the I ² C bus.
17	VCC1	+5 volts +/-5%
18	VCC3	+5 volts +/-5%
19	OVCR*	Over Current Detect – This signal indicates a USB over-current condition.
20	NC	Not Connected (GPCS*)
21	EXTSMI*	Extern System Management Interrupt – This signal is provided by external circuitry to initiate an SMI event with the XTX 820.

Pin #	Signal	Description
22	I ² DAT	I ² C Data – This data line supports the I ² C bus which supports external slave devices only. The interface I ² C bus is intended for support of EEPROMs and other simple I/O-devices. The data rate is approximate 1-10kHz.
23	SMBCLK	System Management Bus Clock – This signal is used to support internal and external SMBus devices, such as temperature and battery monitoring.
24	SMBDATA	System Management Bus Data – This signal is used to support internal and external SMBus devices, such as temperature and battery monitoring.
25	NC	Not Connected (SIDE_CS3*)
26	SMBALRT*	System Management Bus Alert – This signal is used by SMBus devices to signal an event on the SM Bus.
27	NC	Not Connected (SIDE_CS1*)
28	NC	Not Connected (DASP_S)
29	NC	Not Connected (SIDE_A2)
30	PIDE_CS3*	Primary Chip Select 3 – Selects host-accessible Command Block Register.
31	NC	Not Connected (SIDE_A0)
32	PIDE_CS1*	Primary Chip Select 1 – Selects host-accessible Command Block Register.
33	GND2	Ground
34	GND4	Ground
35	NC	Not Connected (PDIAG_S)
36	PIDE_A2	Primary Drive Address Bus 2 – Used (0 to 2) to indicate which byte in the ATA command block or control block (register) is being accessed.
37	NC	Not Connected (SIDE_A1)
38	PIDE_A0	Primary Drive Address Bus 0 – Refer to PIDE_A2, pin-36, for more information.
39	NC	Not Connected (SIDE_INTRQ)
40	PIDE_A1	Primary Drive Address Bus 1 – Refer to PIDE_A2, pin-36, for more information.
41	BATLOW*	Battery Low – This external signal to the XTX 820 indicates when the external battery is low.
42	GPE1*	General Purpose Power Management Event Input 1 – This signal may be driven low by external circuitry to signal an external power management event. This pin is commonly connected to the chipset's LID# input.
43	NC	Not Connected (SIDE_AK*)
44	PIDE_INTRQ	Primary Drive Interrupt Request (IRQ 14)– Asserted by drive when it has pending interrupt (PIO transfer of data to or from the drive to the host).
45	NC	Not Connected (SIDE_RDY)
46	PIDE_AK*	Primary DMA Channel Acknowledge – Used by the host to acknowledge data has been accepted or data is available. Used in response to PIDE_DMARQ asserted.
47	NC	Not Connected (SIDE_IOR*)
48	PIDE_RDY	Primary I/O Channel Ready – When negated extends the host transfer cycle of any host register access when the drive is not ready to respond to a data transfer request. High impedance if asserted.
49	VCC2	+5 volts +/-5%

Pin #	Signal	Description
50	VCC4	+5 volts +/-5%
51	NC	Not Connected (SIDE_IOW*)
52	PIDE_IOR*	Primary Drive I/O Read – Primary strobe signal for read functions. Negative edge enables data from a register or data port of the drive onto the host data bus. Positive edge latches data at the host.
53	NC	Not Connected (SIDE_DRQ)
54	PIDE_IOW*	Primary Drive I/O Write – Primary strobe signal for write functions. Negative edge enables data from a register or data port of the drive onto the host data bus. Positive edge latches data at the host.
55	NC	Not Connected (SIDE_D15)
56	PIDE_DRQ	Primary DMA Request – Used for DMA transfers between host and drive (direction of transfer controlled by IOR* and IOW*). Also used in an asynchronous mode with ACK*. Drive asserts an IRQ when ready to transfer or receive data.
57	NC	Not Connected (SIDE_D0)
58	PIDE_D15	Primary Disk Data 15 – These signals (0 to 15) provide the Primary IDE disk data signals.
59	NC	Not Connected (SIDE_D14)
60	PIDE_D0	Primary Disk Data 0 – Refer to pin-58 for more information.
61	NC	Not Connected (SIDE_D1)
62	PIDE_D14	Primary Disk Data 14 – Refer to pin-58 for more information.
63	NC	Not Connected (SIDE_D13)
64	PIDE_D1	Primary Disk Data 1 – Refer to pin-58 for more information.
65	GND5	Ground
66	GND7	Ground
67	NC	Not Connected (SIDE_D2)
68	PIDE_D13	Primary Disk Data 13 – Refer to pin-58 for more information.
69	NC	Not Connected (SIDE_D12)
70	PIDE_D2	Primary Disk Data 2 – Refer to pin-58 for more information.
71	NC	Not Connected (SIDE_D3)
72	PIDE_D12	Primary Disk Data 12 – Refer to pin-58 for more information.
73	NC	Not Connected (SIDE_D11)
74	PIDE_D3	Primary Disk Data 3 – Refer to pin-58 for more information.
75	NC	Not Connected (SIDE_D4)
76	PIDE_D11	Primary Disk Data 11 – Refer to pin-58 for more information.
77	NC	Not Connected (SIDE_D10)
78	PIDE_D4	Primary Disk Data 4 – Refer to pin-58 for more information.
79	NC	Not Connected (SIDE_D5)
80	PIDE_D10	Primary Disk Data 10 – Refer to pin-58 for more information.
81	VCC5	+5 volts +/-5%
82	VCC6	+5 volts +/-5%

Pin #	Signal	Description
83	NC	Not Connected (SIDE_D9)
84	PIDE_D5	Primary Disk Data 5 – Refer to pin-58 for more information.
85	NC	Not Connected (SIDE_D6)
86	PIDE_D9	Primary Disk Data 9 – Refer to pin-58 for more information.
87	NC	Not Connected (SIDE_D8)
88	PIDE_D6	Primary Disk Data 6 – Refer to pin-58 for more information.
89	GPE2*	General Purpose Power Management Event Input 2. This signal may be driven low by external circuitry to signal an external power management event. This pin is commonly connected to the chipset's RING# input.
90	CBLID_P*	Primary Cable ID Select – Used to detect the presence of an 80 conductor IDE cable on the primary IDE channel. This allows BIOS or system software to determine if is necessary to enable the high-speed transfer modes (DMA66 or DMA100).
91	RXD-	Half of Ethernet Analog Twisted Pair Receive Differential Pair – This pin and pin-93 make up the Receive twisted pair and receive the serial bit stream on the Unshielded Twisted Pair Cable (UTP).
92	PIDE_D8	Primary Disk Data 8 – Refer to pin-58 for more information.
93	RXD+	Half of Ethernet Analog Twisted Pair Receive Differential Pair – Refer to pin-91 for more information.
94	NC	Not Connected (SIDE_D7)
95	TXD-	Half of Ethernet Analog Twisted Pair Transmit Differential Pair – This pin and pin-97 make up the Transmit twisted pair and transmit the serial bit stream on the Unshielded Twisted Pair Cable (UTP).
96	PIDE_D7	Primary Disk Data 7 – Refer to pin-58 for more information.
97	TXD+	Half of Ethernet Analog Twisted Pair Transmit Differential Pair – Refer to pin-95 for more information.
98	HDRST*	Hard Reset – Low active hardware reset (RSTDRV inverted)
99	GND6	Ground
100	GND8	Ground

Notes: The shaded area denotes power or ground. The signals marked with * = Negative true logic.

Miscellaneous

SDVO Port

The SDVO (Serial Digital Video Output) ports are supported through the J6 connector located on the underside of XTX 820. This interface supports external transmitters such as DVI, TV-Out, and LVDS, etc. that are required to provide the respective signals.

- Provides two Intel compliant SDVO ports
- Supports pixel rates up to 200 MP/s (600 MB/s) transfer speed on each port

Table 3-29. SDVO Interface Pin/Signal Descriptions (J6)

Pin #	Signal	Description
1	GND	Ground
2	SDVOC_BCLKN	Serial Digital Video C clock complement
3	SDVOC_BCLKP	Serial Digital Video C clock
4	GND	Ground
5	SDVOC_GREEN*	Serial Digital Video C green complement.
6	SDVOC_GREEN	Serial Digital Video C green.
7	GND	Ground
8	SDVOB_BCLKN	Serial Digital Video B clock complement .
9	SDVOB_BCLKP	Serial Digital Video B clock.
10	GND	Ground
11	SDVOB_GREEN*	Serial Digital Video B green data complement.
12	SDVOB_GREEN	Serial Digital Video B green data.
13	GND	Ground
14	SDVOC_INT*	Serial Digital Video input interrupt complement.
15	SDVOC_INT	Serial Digital Video input interrupt.
16	GND	Ground
17	SDVOB_INT*	Serial Digital Video input interrupt complement.
18	SDVOB_INT	Serial Digital Video input interrupt.
19	GND	Ground
20	SDVOC_BLUE*	Serial Digital Video C blue complement.
21	SDVOC_BLUE	Serial Digital Video C blue data.
22	GND	Ground
23	SDVOC_RED*	Serial Digital Video C red data complement / alpha complement.
24	SDVOC_RED	Serial Digital Video C red data / SDVO B alpha.
25	GND	Ground
26	SDVOB_BLUE*	Serial Digital Video B blue data complement.
27	SDVOB_BLUE	Serial Digital Video B blue data
28	GND	Ground
29	SDVOB_RED*	Serial Digital Video B red data complement.
30	SDVOB_RED	Serial Digital Video B red data.

Pin #	Signal	Description
31	GND	Ground
32	SDVO_FLDSTALL*	Serial Digital Video field stall complement.
33	SDVO_FLDSTALL	Serial Digital Video field stall.
34	GND	Ground
35	SDVO_TVCLKIN*	Serial Digital Video TV-Out synchronization clock complement.
36	SDVO_TVCLKIN	Serial Digital Video TV-Out synchronization clock.
37	GND	Ground
38	SDVOCTRL_CLK	I ² C based control signal (Clock) for SDVO device. PU 2k2 3.3V
39	SDVOCTRL_DATA	I ² C based control signal (Data) for SDVO device. PU 2k2 3.3V
40	PWRGD	Power Good tied to Pull Up 10k resistor at 3.3V
41	+5V	Power supply +5V
42	+5V	Power supply +5V
43	+5V	Power supply +5V
44	SDAOUFP1	Custom
45	SDAOUFP2	Custom

Notes: The shaded area denotes power or ground. The signals marked with * = Negative true logic.

Serial Console (Remote Access)

The XTX 820 supports the serial console (or console redirection) feature as Remote Access in the BIOS Setup Utility. This I/O function can be accessed by an ANSI-compatible serial terminal, or the equivalent terminal emulation software running on another system. This can be very useful when setting up the BIOS on a production line for systems that are not connected to a keyboard and display.

Serial Console Setup

The serial console feature is implemented by connecting a standard null modem cable between one of the serial ports, such as Serial 1 (COM1) or Serial 2 (COM2), and the serial terminal or a PC with communications software. The BIOS Setup Utility controls the serial console settings for the XTX 820. Refer to Chapter 4, *BIOS Setup Utility* for the Remote Access (serial console) settings, and the settings for the serial terminal, or PC with communications software. A brief connection procedure is also provided in Chapter 4, under *Accessing BIOS Setup Utility (Remote Access)*.

Temperature Monitoring

Pentium/Celeron M processors make use of the thermal monitor feature to help control the processor temperature. The maximum junction operating temperature for Pentium/Celeron M processors is 100°C. The integrated TCC (Thermal Control Circuit) activates if the processor die reaches its maximum operating temperature. The activation temperature used by the Intel Thermal Monitor activates the TCC, but cannot be configured by the user nor is it software visible.

The Thermal Monitor can control the processor temperature through the use of two different methods defined as TM1 and TM2. The TM1 method modulates (starts and stops) the processor clock at a 50% duty cycle. The TM2 method initiates an Enhanced Intel Speedstep transition to the lowest performance state once the processor silicon reaches the maximum operating temperature and is only supported by Intel Pentium M processors. The TM2 mode should only be used for Intel Pentium M processors and is not supported by Intel Celeron M processors.

The Thermal Monitor supports two modes (Automatic and On-Demand) to activate the TCC. The Intel Thermal Monitor Automatic Mode must be enabled through a setup node in the BIOS. No additional hardware, software, or handling routines are necessary when using Automatic Mode.

To ensure the impact on processor performance is reduced to a minimum, the TCC can only be active for short periods of time, which requires a properly designed thermal solution. The Intel Pentium/Celeron M processor datasheet can provide you with more information.

The thermal trip signal is used by Intel's Pentium/Celeron M processors for catastrophic thermal protection. If the processor's silicon reaches a temperature of approximately 125°C then the processor's thermal trip signal will go active and the system will automatically shut down to prevent any damage to the processor as a result of overheating. The thermal trip signal activation is completely independent from processor activity and therefore does not produce any bus cycles.

NOTE	An ATX power supply is required to make use of the thermal trip signal and automatically switch off the system.
-------------	---

Watchdog Timer (WDT)

The watchdog timer (WDT) restarts the system if an error or mishap occurs, allowing the system to recover from the mishap, even though the error condition may still exist. Possible problems include failure to boot properly, the application software's loss of control, failure of an interface device, unexpected conditions on the bus, or other hardware or software malfunctions.

The WDT (watchdog timer) can be used both during the boot process and during normal system operation.

- During the Boot process – If the operating system fails to boot in the time interval set in the BIOS, the system will reset.

The watchdog timer (WDT) is enabled and configured in the BIOS Setup Utility screen, Advanced BIOS Features. Set the WDT for a time-out interval in seconds or minutes (between 30 sec to 30 min) in the Advanced BIOS Features screen. Ensure you allow enough time for the boot process to complete and for the OS to boot. The OS or application must tickle (reset) the WDT before the timer expires. This can be done by accessing the hardware directly or through a BIOS call.

- During System Operation – An application can set up the WDT hardware through a BIOS call, or by accessing the hardware directly. Some Ampro Board Support Packages provide an API interface to the WDT. The application must tickle (reset) the WDT before the timer expires or the system will be reset.
- Watchdog Setup – Ampro has provided a System Utility which helps you set up the WDT. The System Utility and its user guide are located on the XTX 820 Doc & SW CD-ROM. Refer also to Ampro's Watchdog Timer Application Note.

Power Input

The XTX 820 generates its own voltages on the board and only requires an external +5 volts through the four connectors (X1, X2, X3, X4) on the custom baseboard. All the XTX 820 module voltages are derived from the externally supplied +5 volts DC +/- 5%. The onboard voltages provide the CPU core voltages as well as other voltages used on the module.

Table 3-30 gives the pin outs and signals for typical ATX Power supply connector.

Table 3-30. Typical ATX Power Interface Pin/Signal Descriptions

Pin #	Signal	Description	Pin #	Signal	Description
1	+3.3V	+3.3 volts DC +/- 5%	2	+3.3V	+3.3 volts DC +/- 5%
3	GND	Ground	4	+5V	+5.0 volts DC +/- 5%
5	GND	Ground	6	+5V	+5.0 volts DC +/- 5%
7	GND	Ground	8	PWROK	Power Ok or Good signal from ATX Power supply
9	5V_SB	+5.0 suspend voltage (+5V, 100mA Standby)	10	+12V	This +12V is are for BUS power only (optional)
11	+3.3V	+3.3 volts DC +/- 5%	12	-12V	This -12V is are for BUS power only (optional)
13	GND	Ground	14	PS_ON*	Enable signal for ATX power supply
15	GND	Ground	16	GND	Ground
17	GND	Ground	18	-5V	-5.0 volts DC +/- 5%
19	+5V	+5.0 volts DC +/- 5%	20	+5V	+5.0 volts DC +/- 5%

Notes: The shaded area denotes power or ground. The +12V and +3.3V on a typical ATX power input connector are used for the PCI bus and LCD panels, and are supplied from the external ATX power supply. The -5V and -12V are also supplied from the external ATX power supply.

NOTE If you use a non-ATX type power supply (AT or lab power supply) to power up the XTX baseboard, you must set the jumper on the Ampro XTX Baseboard for a non-ATX power supply use.

Power and Sleep States

The following information only applies if an ATX power supply is connected to the XTX 820 and its respective XTX baseboard. If a non-ATX power supply is used, then the XTX 820 is only controlled by the Power-On/Off switch on the power supply and the various sleep states are not available. The ACPI sleep states are OS dependent and not available if your OS does not support power management based on the ACPI standard. The signals used for control of the ATX power supply and sleep states in general are located in Table 3-30 and described in more detail under topics *Power Control Signals* and *Power Management Signals* earlier in this chapter.

Power-On Switch

The Power-On switch on or connected to the XTX Baseboard, turns the XTX 820 and the attached power supply to a fully On condition, if you are using an ATX power supply. If the operating system (OS) supports sleep states, the OS will turn off the XTX 820 and its power supply during the OS shut down process. Typically, the Power-On switch will also transition the XTX 820 and the power supply between a fully powered on state and the various sleep states, including a fully powered off state. If the OS does not support sleep states, then the Power-On switch only turns power, On or Off, to the XTX 820 and the baseboard.

Typically, an OS that supports ACPI, also allows the Power-On switch to be configured through a user interface. The Power-On switch for the XTX 820 must be provided on, or connected to the baseboard.

Sleep States (ACPI)

The XTX 820 supports the ACPI (Advanced Configuration and Power Interface) standard, which is a key component of certain Operating Systems' (OS's) power management. The supported features (sleep states) listed here are only available when an ACPI-compliant OS is used for the XTX 820, such as Windows 2000/XP. The term "sleep state" refers to a low wake latency (reduced power consumption) state, which can be re-started (awakened) restoring full operation to the XTX 820.

In these various sleep states, the computer appears to be off, indicated by such things as no display on the attached monitor and no activity for the connected CD-ROM or hard drives. Normally, when a computer detects certain activity (i.e. power switch, mouse, keyboard, serial port, or certain types of LAN activity), it returns to a fully operational state.

NOTE

Currently, the Power-On switch, SMBus Alert, Wake-on-Ring, Wake-on-LAN, Wake on PME, and Keyboard/Mouse activity are the only activities that will wake the XTX 820 from a powered down state (soft off), such as Standby (S1), Suspend-to-RAM (S3), Hibernate (S4) and Power Off (S5). However, not all of the listed activities (called "wake events") will wake each sleep state. Refer to *Wake Up Activities* and the XTX 820 Software and Hardware Release Notes for more information.

The XTX 820 supports at least five ACPI power states, depending on the operating system used and its ability to manage sleep states. Typically, the Power-On switch is used to wake up from a sleep state, or transition from one state to another, but this is dependent on the operating system.

- 1st state is normal Power On (S0).
 - ◆ To go to a fully powered on state, the XTX 820 must either be powered Off (S5), or in a sleep state (S1 or S4), and then the Power-On switch is pressed for less than 4 seconds (default).
 - ◆ The XTX 820 can transition from this state (S0) to the various states described below, depending on the power management capability of the OS and how it is programmed.
- 2nd state is a standby state (S1).

In this state there are no internal operations taking place, except for the internal RTC (real time clock) and the contents of RAM. This includes no activity for the CPU, CD-ROM, or hard disk drives. The XTX 820 appears to be off including any power-on LED indicators.

- ◆ Normally, to enter this sleep state, the XTX 820 must be fully powered on (S0) and the OS transitions the XTX 820 into this standby state (S1) under user control.
- ◆ To exit this sleep state a wake up event, such as the Power-On switch, is used to wake up the XTX 820 and restore full operation, including any power LED indicators. Typically, pressing the Power-On switch for less than 4 seconds (default) will restore full operation.
- 3rd state is a suspend-to-RAM state (S3).

In this state there are no internal operations taking place, except for the internal RTC (real time clock) and the contents of RAM. This includes no activity for the CPU, CD-ROM, or hard disk drives. The XTX 820 appears to be off including any power LED indicators.

- ◆ Normally, to enter this sleep state, the XTX 820 must be fully powered on (S0) and the OS transitions the XTX 820 into this suspend-to-RAM (S3) state under user control.
- ◆ To exit this sleep state a wake up event, such as the Power-On switch, is used to wake up the XTX 820 and restore full operation, including any power LED indicators. Typically, pressing the Power-On switch for less than 4 seconds (default) will restore full operation.

- 4th state is a hibernate or suspend-to-disk state (S4).

In this state there are no internal operations taking place, except for the internal RTC. This includes no activity for the RAM, CPU, CD-ROM, or hard disk drives. The XTX 820 appears to be off, including any power LED indicators. Your system will take longer to wake-up in this sleep state, however, since your data is saved to the disk, it is more secure and should not be lost in the event of a power failure.

- ◆ To enter a hibernate or suspend-to-disk state, the XTX 820 must be fully powered on and the OS transitions the XTX 820 into this sleep state (S4) under user control.
- ◆ To exit this sleep state a wake up event, such as the Power-On switch, is used to wake up the XTX 820 and restore full operation, including any power LED indicators. Typically, pressing the Power-On switch for less than 4 seconds (default) will restore full operation.

- 5th state is the normal power Off or shutdown (S5).

All activity stops except the internal clock, unless the power cord is removed from the power source.

- ◆ To go to a fully powered down state (soft off), the XTX 820 must either be powered On, or in a sleep state, and then the Power-On switch is pressed for more than 4-to-6 seconds.
- ◆ To go to a fully powered up state, press the Power-On switch for less than 4 seconds (default) and full operation is restored.

The OS may provide additional programming features to change the activation time for each state, and to shutdown or transition the XTX 820 at certain times. Refer to the OS vendor's documentation for power management under the ACPI standard.

Wake Up Activities

The wake up events listed in Table 3-31 can be used to wake up the XTX 820 from S3 or any of the other states mentioned.

Table 3-31. Wake Up Activities and Conditions

Signal/Device	Condition
SMBALRT*	When set to Always
GEP2* (RI*)	If this pin is configured as Sleep button in BIOS Setup.
GEP1*	If this pin is configured as a LID switch in BIOS Setup and used to transition to S3. A release of this signal wakes the system from S3.
PCE_WAKE*	When set to Always
Integrated LAN	The LAN driver configuration allows the system to wake from S3/S4 and even S5 through direct addressing, magic packets, or link status changes.
PS/2 Keyboard & Mouse	If powered by standby voltage on baseboard.
Integrated USB	If configured as S3/S4 wake device in BIOS Setup and if powered by standby voltage. Example, USB mouse could wake the system.
PME*	Activated by Windows ACPI system if the PCI driver indicates that it manages a device capable of waking up the system.

Note: The signals marked with * = Negative true logic.

Introduction

This chapter describes the BIOS Setup Utility menus and the various screens used for configuring the XTX 820. Some features in the Operating System or application software may require configuration in the BIOS Setup screens.

This section assumes the user is familiar with general BIOS Setup and does not attempt to describe the BIOS functions. Refer to the appropriate PC reference manuals for information about the onboard ROM-BIOS software interface. If Ampro has added to or modified the standard functions, these functions will be described.

The options provided for the XTX 820 are controlled by BIOS Setup. BIOS Setup is used to configure the board, modify the fields in the Setup screens, and save the results in the onboard configuration memory. Configuration memory consists of portions of the CMOS RAM in the battery-backed real-time clock chip and the flash memory.

The Setup information is retrieved from configuration memory when the board is powered up or when it is rebooted. Changes made to the Setup parameters, with the exception of the time and date settings, do not take effect until the board is rebooted.

Setup is located in the ROM BIOS and can be accessed while the board is in the Power-On Self Test (POST) state, just before starting the boot process. Typically, the screen displays a message indicating when you can press to enter the BIOS Setup Utility.

The XTX 820 BIOS Setup Utility is used to configure items in the BIOS using the following menus:

- Main
- Advanced
- Boot
- Security
- Power
- Exit

Table 4-1 summarizes the list of BIOS menus and some of the features available for XTX 820. The BIOS Setup menu offers the menu choices listed above and the related topics and screens are described on the following pages.

Accessing BIOS Setup Utility (VGA Display)

To access the BIOS Setup Utility using a VGA display for the XTX 820:

1. Turn on the VGA monitor and the power supply to the XTX 820 and baseboard assembly.
2. Start Setup by pressing the [Del] key, when the following message appears on the boot screen.

```
Hit <Del> if you want to run SETUP
```

NOTE	If the setting for <i>Quick Boot</i> is set to [Enabled], you may not see this prompt appear on screen if the monitor is too slow to display it on start up. If this happens, press the key early in the boot sequence to enter the BIOS Setup Utility.
-------------	---

3. Use the <Enter> key to select the screen menus listed in the Opening BIOS screen. See Figure 4-1.
4. Follow the instructions at the right of each screen to navigate through the selections and modify any settings.

Accessing BIOS Setup Utility (Remote Access)

Once you set up the BIOS Utility for Remote Access (serial console or console redirection) in VGA mode, entering the BIOS in the remote access mode, is very similar to the method used in entering the BIOS with a VGA display.

1. Turn on the power supply to the XTX 820 baseboard assembly and access the BIOS Setup Utility in VGA mode.
2. Set the BIOS feature *Remote Access* to [Enabled] under the **Advanced** menu.
3. Accept the default options or make your own selections for the balance of the Remote Access fields and record your settings.
4. Ensure you select the type of remote serial terminal you will be using and record your selection.
5. Select *Save Changes and Exit* and then shut down the XTX 820 baseboard assembly.
6. Connect the remote serial terminal (or the PC with communications software) to the COM port you selected on the XTX baseboard using a standard null-modem serial cable.
7. Turn on the remote serial terminal (or the PC with communications software) and set it to the settings you selected and recorded earlier in the BIOS Setup Utility.

COM1, 115200, 8 bits, 1 stop bit, no parity, no flow control, and always *for Redirection after BIOS Post* are the default settings for the XTX 820.

8. Restore power to the XTX 820 baseboard assembly and look for the screen prompt shown below.

Hit ^C if you want to run SETUP

9. Press the CTRL-C keys early in the boot sequence if *Quick Boot* is set to [Enabled].

If *Quick Boot* is set to [Enabled], you may never see the screen prompt.

10. Use the <Enter> key to select the screen menus listed in the Opening BIOS screen. See Figure 4-1.

Table 4-1. BIOS Setup Utility Menus

BIOS Setup Utility Menu	Item/Topic
Main Settings	Date and Time
Advanced Settings	ACPI Configuration, PCI Configuration, Graphics Configuration, CPU Configuration, Chipset Configuration, I/O Interface Configuration, Clock Configuration, IDE Configuration, USB Configuration, Keyboard/Mouse Configuration, Remote Access (Serial Console) Configuration, Hardware Health Configuration, and Watchdog Configuration
Boot	Boot up Settings Configuration, Boot Device Priority, Removable Drives
Security	Setting or changing Supervisor/User Passwords, Boot Sector Virus Protection, and Hard Disk Security
Power	Power Management (APM) and Resume Power conditions
Exit	Exiting with or without changing settings, Loading CMOS Defaults

BIOS Menus

BIOS Main Setup Screen

BIOS Setup Utility					
Main	Advanced	Boot	Security	Power	Exit
System Time		[15:21:33]		Use [ENTER], [TAB] or [SHIFT-TAB] to select a field.	
System Date		[Fri 09/08/2006]			
BIOS ID		: P915Rxxx		Use[+] or [-] to configure system time.	
OEM Version		: S0xxxxxx			
Processor		: Intel(R) Pentium(R) M processor 1.4 GHz		Select Screen Select Item + - Change field Tab Select Field F1 General Help F10 Save and Exit ESC Exit	
CPU Frequency		: 1399MHz			
System Memory		: 1016MB			
Board Information					
Product Revision		: xx			
Serial Number		: xxxxx			
BC Firmware Rev		: xxx			
Boot Counter		: xxx			
Running Time		: xxxx			

V02.xx (C) Copyright 1985-2004, American Megatrends, Inc.

Figure 4-1. BIOS Main Setup Screen

System Time and Date

- System Time (hh:mm:ss) – This is a 24-hour clock setting in hours, minutes, and seconds
- System Date (day of week, mm:dd:yyyy) – This field requires the alpha-numeric entry of the day of the week, calendar month, day of the month, and all 4 digits of the year, indicating the century plus year (*Fri 09/08/2006*). The day of the week changes with the other settings.

The balance of this screen provides the characteristics or parameters of the XTX 820 module installed on the XTX baseboard. These characteristics or parameters on screen can not be changed.

NOTE	The CMOS Default values are shown highlighted as bold text .
	Refer to the right of the BIOS screens for the navigation instructions when making selections.

Table 4-2. Exiting and Loading Default Keys

Key	Description
<ESC>	Discard Changes without leaving BIOS Setup Utility
F7	Discard Changes and Exit
F9	Load CMOS default settings.
F10	Save Changes and Exit BIOS Setup Utility

BIOS Advanced Setup Screen

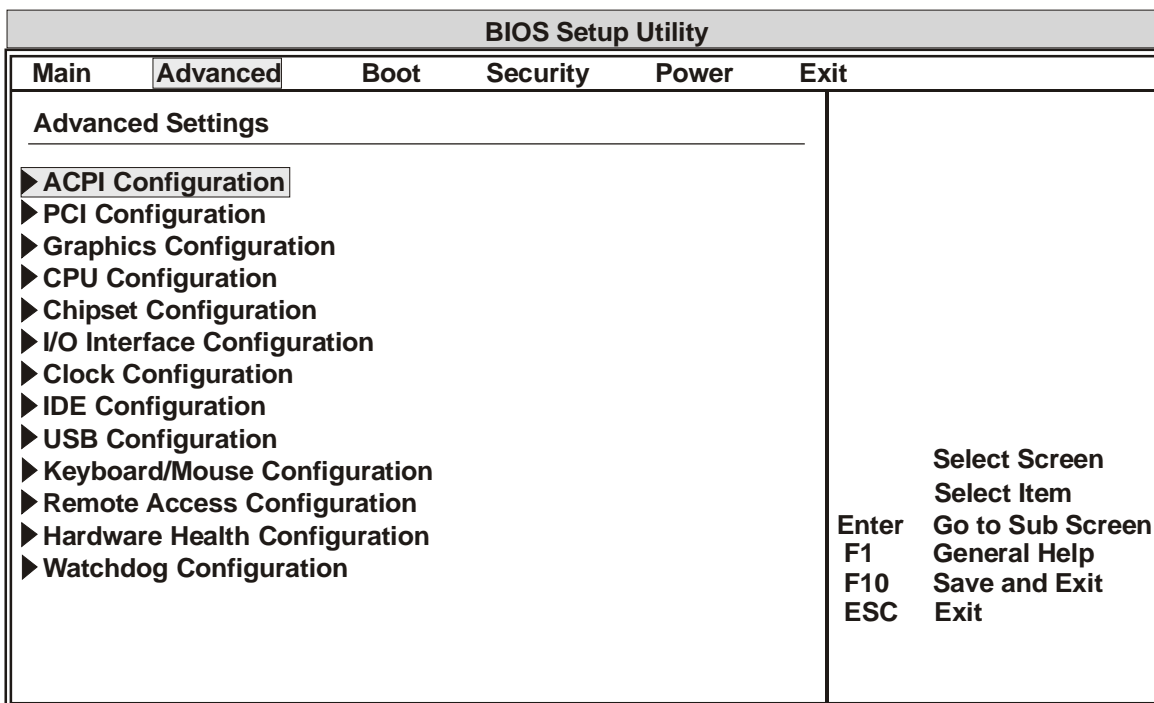

V02.xx (C) Copyright 1985-2004, American Megatrends, Inc.

Figure 4-2. BIOS Advanced Setup Screen

Advanced Settings

>ACPI Configuration

- ACPI Aware O/S – [No] or [Yes]
 - * If this field is set to [No], all of the following ACPI options do not appear on screen.
- ◆ ACPI 2.0 Features – [No] or [Yes]
- ◆ ACPI APIC support – [Disabled] or [Enabled]
- ◆ Suspend Mode – [S1 (POS)] or [S3 (STR)]
- ◆ USB Device Wakeup from S3/S4 – [Disabled] or [Enabled]
- ◆ Active Cooling Trip Point – [Disabled], [50°C], [60°C], [70°C], [80°C], or [90°C]
This field determines the CPU temperature at which the OS switches the fan On/Off.
- ◆ Passive Cooling Trip Point – [Disabled], [50°C], [60°C], [70°C], [80°C], or [90°C]
This field determines the CPU temperature at which the OS activates CPU Clock throttling.
- ◆ Critical Trip Point – [Disabled], [80°C], [85°C], [90°C], [95°C], [100°C], [105°C], or [110°C]
This field determines the CPU temperature at which the OS shuts down the system.
- ◆ Watchdog ACPI Event – [Shutdown] or [Restart]
This field selects the even that is initiated by the WDT ACPI event. Either one of these options will perform a critical but orderly OS shutdown or restart.
- ◆ GPE1 Function – [No Function] or [Lid Switch]
This field determines the function of the GPE1 pin on J4 (X4), pin-42 connector of the XTX 820.

- ◆ GPE2 Function – [**No Function**] or [Sleep Button]

This field determines the function of the GPE2 pin on J4 (X4), pin-89 connector of the XTX 820.

>PCI Configuration

- Plug & Play O/S – [**No**] or [Yes]

* If [No] is selected, the BIOS is allowed to configure all the devices in the system.

* If [Yes] is selected, the Operating System (OS) is allowed to change the interrupt, I/O, and DMA settings for the devices in the system. This is only used by Plug & Play capable OSs.

- PCI Latency Timer – [32], [**64**], [96], [128], [160], [192], [224], or [248]

This feature sets the latency of all PCI devices on the PCI bus. The various settings allow the PCI Latency timer to be adjusted to the number of clock cycles specified. The default setting [64] adjust the PCI Latency timer to 64 PCI clock cycles.

- Allocate IRQ to PCI VGA – [**Yes**] or [No]

This field allows or restricts the system from giving the VGA adapter card an interrupt address.

* If [Yes] is selected, the BIOS is allowed to allocate an IRQ to any VGA adapter card that uses the PCI local bus.

>PCI IRQ Resource Exclusion

- ◆ IRQ3 – [**Available**] or [Reserved]
- ◆ IRQ4 – [**Available**] or [Reserved]
- ◆ IRQ5 – [**Available**] or [Reserved]
- ◆ IRQ6 – [**Available**] or [Reserved]
- ◆ IRQ7 – [**Available**] or [Reserved]
- ◆ IRQ9 – [**Available**] or [Reserved]
- ◆ IRQ10 – [**Available**] or [Reserved]
- ◆ IRQ11 – [**Available**] or [Reserved]
- ◆ IRQ12 – [**Available**] or [Reserved]
- ◆ IRQ14 – [**Available**] or [Reserved]
- ◆ IRQ15 – [**Available**] or [Reserved]

>PCI Interrupt Routing

- ◆ PIRQ A (VGA, Azalia, PCIEX1) – [**Auto**]. [3], [4], [5], [7], [9], [10], [11], [12], [14], or [15]
- ◆ PIRQ B (AC97, PCIEX2) – [**Auto**]. [3], [4], [5], [7], [9], [10], [11], [12], [14], or [15]
- ◆ PIRQ C (PATA, UHCI2, PCIEX3) – [**Auto**]. [3], [4], [5], [7], [9], [10], [11], [12], [14], or [15]
- ◆ PIRQ D (SATA, UHCI1, SMB, PCIEX4) – [**Auto**]. [3], [4], [5], [7], [9], [10], [11], [12], [14], or [15]
- ◆ PIRQ E (INTA, Onboard LAN) – [**Auto**]. [3], [4], [5], [7], [9], [10], [11], [12], [14], or [15]
- ◆ PIRQ F (INTB) – [**Auto**]. [3], [4], [5], [7], [9], [10], [11], [12], [14], or [15]
- ◆ PIRQ G (INTC) – [**Auto**]. [3], [4], [5], [7], [9], [10], [11], [12], [14], or [15]
- ◆ PIRQ H (INTD, UHCI0, EHCI) – [**Auto**]. [3], [4], [5], [7], [9], [10], [11], [12], [14], or [15]

Definition of Terms

PCIEXn : PCI Express Root Port n

INTn : External PCI Bus INTn Line

- PATA** : Parallel ATA in Enhanced/Native Mode
- SATA** : Serial ATA in Enhanced/Native Mode
- SMB** : System Management Bus Controller
- Azalia** : Intel High Definition Audio

>Graphics Configuration

- Primary Video Device – [Internal VGA] or [**PCI/Int-VGA**]
- Internal VGA Mode Select – [Disabled], [Enabled, 1 MB], or [**Enabled, 8 MB**]
 - ◆ Aperture Size Select – [**256 MB**] or [128 MB]
- DVMT Mode Select – [Fixed Mode], [**DVMT Mode**], or [Combo Mode]
 - ◆ DVMT/Fixed Memory – [64 MB] or [**128 MB**]
- Boot Display Device – [Auto], [CRT only], [TV only], [SDVO only], [CRT + SDVO], [LFP only], or [**CRT + LFP**]
- Local Flat Panel (LFP) Type [**Auto**] or [Select a pre-defined flat panel in Table 4-3]

Selecting [Auto] allows the BIOS to detect and configure the attached flat panel. Auto detection is performed by reading an EDID data set over the video I²C bus.

Refer to Table 4-3 for the list of predefined LVDS flat panels with the supported resolutions and flat panel types. Some LVDS panels may require video BIOS modifications. If you think this is the case, or would like help in setting up your LVDS panel, contact Ampro for assistance with the LVDS panel adaptation.

- Local Flat Panel Scaling – [**Centering**], [Expand Text], [Expand Graphics], or [Expand Text & Graphics]

Table 4-3. Local Flat Panel Type List

#	Flat Panel Resolution	BITs
1	Auto	
2	VGA (002h)	1x18
3	VGA (013h)	1x18
4	SVGA (004h)	1x18
5	XGA (006h)	1x18
6	XGA (007h)	2x18
7	XGA (008h)	1x24

#	Flat Panel Resolution	BITs
8	XGA (012h)	2x24
9	SXGA (00Ah)	2x24
10	UXGA (00Ch)	2x24
11	Customized EDID™ 1	
12	Customized EDID™ 2	
13	Customized EDID™ 3	
14		

Note: The characters in parenthesis (0xxh) represent the video I²C bus address for the respective flat panel resolution.

- Backlight Control – [**100%**], [75.0%], [50%], [25%], or [0%]
- SDVO Port B Device – [None], [**DVI**], [TV], [CRT], or [LVDS]

This field selects the SDVO device connected to this SDVO port B. This SDVO port requires an external transmitter that matches the SDVO device connected.
- SDVO Port C Device – [None], [**DVI**], [TV], [CRT], or [LVDS]

This field selects the SDVO device connected to this SDVO port C. This SDVO port requires an external transmitter that matches the SDVO device connected.
- TV Standard – [**VBIOS-Default**], [NTSC], [PAL], [SECAM], [SMPTE240M], [ITU-R Television], [SMPTE295M], [SMPTE296M], [EIA-770.2], or [EIA-770.3]

>CPU Configuration

The following is an example CPU configuration, which is based on the model and configuration of the XTX 820 COM.

Configure advanced CPU settings

Mobile version - 13.xx

Manufacture : Intel

Brand String : Intel® Pentium® M processor 1.40GHz

Frequency : 1.40GHz

FSB Speed : 400MHz

Cache L1 : 32kB

Cached L2 : 2048kB

- Execute Disable Bit – [Disabled] or **[Enabled]**

This feature is only appears for Celeron CPUs that support it.

* If [Disabled] is selected, it forces the XD feature flag to always return to 0.

- On Demand Clock Modulation – **[Disabled]**, [25%], [50%], or [75%]

This feature uses on demand clock throttling or modulation to reduce the performance of Celeron-M CPUs and is only supported by the Celeron-M CPUs. The % value indicates the CLOCK ON to CLOCK OFF interval ratio. If 75% is selected, the CPU performance is decreased by about 25%.

- Intel® SpeedStep™ Technology – [Maximum Speed], [Minimum Speed], **[Automatic]**, or [Disabled]

This feature only appears for the Pentium CPUs that support it.

Intel® Mobile Pentium® Processors with Intel® SpeedStep™ technology let you customize high performance computing on your XTX 820 design project. Automatic allows the operating system (OS) to control CPU speed and Disabled uses the default speed of the CPU. If the OS has the control of the CPU speed, it can allow the processor to drop to a lower frequency (by changing the bus ratios) and voltage, conserving battery life while maintaining a high level of performance, when powered by a battery. This allows you to customize performance for the XTX 820 CPU.

- Max. CPU Frequency – [1800 MHz], [1600 MHz], [1400 MHz], [1300 MHz], [1200 MHz], [1100 MHz], [1000 MHz], [900 MHz], [800 MHz], or [600 MHz]

This feature is only available for the Pentium CPUs and the default settings are based on the frequency of the CPU (1800 MHz or 1400 MHz).

>Chipset Configuration

- Memory Hole – **[Disabled]** or [15MB-16MB]

- IOAPIC – [Disabled] or **[Enabled]**

This field sets the IOAPIC function on the I/O Hub (82801FBM) used on the XTX 820.

- APIC ACPI SCI IRQ – **[Disabled]** or [Enabled]

- C4 On C3 – **[Disabled]** or [Enabled]

* If this field is set to [Enabled], the CPU is put into C4 state when the ACPI OS initiates a transition to C3 state. This results in an additional power savings when in desktop idle mode.

>PCI Express Configuration

- ◆ Active State Power-Management – [**Disabled**] or [Enabled]

This field enables or disables PCI Express L0 and L1 link power states.

- PCI Express Port 1 – [Disabled] or [**Enabled**]
- PCI Express Port 2 – [Disabled] or [**Enabled**]
- PCI Express Port 3 – [Disabled] or [**Enabled**]
- PCI Express Port 4 – [Disabled] or [**Enabled**]
- VC1 for Azalia & Root Ports – [**Disabled**] or [Enabled]

This field Enables or Disables Virtual Channel 1 for PCI Express Root Ports and the Azalia controller (Intel High Definition Audio) to support true isochronous data transfers.

>I/O Interface Configuration

- Onboard Audio Controller – [Azalia], [**AC97**], or [Disabled]
 - * If this field is set to [AC97], the onboard AC'97 CODEC is selected.
 - * If this field is set to [Azalia], the onboard Intel High Definition Audio controller is selected.
- Onboard Ethernet Controller – [Disabled] or [**Enabled**]

This field must be set to [Enabled] to use the LAN Boot feature (PXE Boot to LAN).
- Onboard Floppy Controller – [**Disabled**] or [Enabled]
 - * If this field is [Enabled], the onboard floppy controller is selected over the Parallel Port and the entry, 1st Floppy Drive, appears in the boot order under Boot Device Priority when Device Type is selected. You must select a Floppy A type, typically [1.44 MB, 3 1/2"] to use this feature. The Parallel Port can not be enabled since these two devices share the same pins to the baseboard connector.
 - * If this field is [Disabled], the Parallel Port can be Enabled by selecting one of the Parallel port address.
- Floppy A – [**Disabled**], [360 kB, 5 1/4 "], [1.2 MB, 5 1/4"], [720 kB, 3 1/2"], [1.44 MB, 3 1/2"], or [2.88 MB, 3.5"]
- Serial Port 1 Configuration – [Disabled], [**3F8/IRQ4**], [3E8/IRQ4], or [2E8/IRQ3]
- Serial Port 2 Configuration – [Disabled], [**2F8/IRQ3**], [3E8/IRQ4], or [2E8/IRQ3]
 - ◆ Serial Port 2 Mode – [**Normal**], [IrDA], or [ASK IR]
 - * If this field is set to [IrDA] or [ASK IR], the Infrared settings below appear on screen.
 - IR Duplex mode – [**Half Duplex**] or [Full Duplex]
 - IR I/O Pin select – [SINB/SOUTB] or [**IRRX/IRTX**]
- Parallel Port Address – [**Disabled**], [378], [278], or [3BC]

You can only change this feature from [Disabled] to another setting if the Onboard Floppy Controller is set to [Disabled]. If [378], [278], or [3BC] are selected, the following items appear on screen.

- ◆ Parallel Port Mode – [**Normal**], [Bi-Directional], [ECP], [EPP], or [ECP&EPP]
 - * If [Normal] is selected, the standard parallel port mode is used. This is the default setting.
 - * If [Bi-Directional] is selected, the data is sent to and received from the parallel port.
 - * If [ECP] is selected, the ECP Mode DMA Channel appears below. The ECP parallel port can be used with devices adhering to the Extended Capabilities Port (ECP) specification.

ECP uses the DMA protocol to achieve data transfer rates up to 2.5 Megabits per second. ECP also provides symmetric bi-directional communication.

- ECP Mode DMA Channel – [DMA0], [DMA1], or [**DMA3**]
- * If [EPP] is selected, the EPP Version appears below. The EPP parallel port can be used with devices adhering to the Enhanced Parallel Port (EPP) specification. EPP uses the existing parallel port signals to provide asymmetric bi-directional data transfer driven by the host device.
- EPP Version – [**1.9**] or [1.7]
- * If [ECP&EPP] is selected, all of the options for both appear below Parallel Port Mode.
- ◆ Parallel Port IRQ – [IRQ5] or [**IRQ 7**]

If you are not using Ampro's baseboard, the following fields may not be detected by the BIOS and may not appear on screen. These fields are supported by the XTX 820 LPC bus and the Super I/O chip on the Ampro baseboard.

- Serial Port 3 Configuration – [**Disabled**], [3F8/IRQ11], [2F8/IRQ10], [3E8/IRQ11], [2E8/IRQ10], [3F8/IRQ10], [2F8/IRQ11], [3E8/IRQ10], or [2E8/IRQ11]
- Serial Port 4 Configuration – [**Disabled**], [3F8/IRQ11], [2F8/IRQ10], [3E8/IRQ11], [2E8/IRQ10], [3F8/IRQ10], [2F8/IRQ11], [3E8/IRQ10], or [2E8/IRQ11]
- Parallel Port 2 Address – [**Disabled**], [378], [278], or [3BC]

If [378], [278], or [3BC] are selected, the following items appear on screen.

- ◆ Parallel Port 2 Mode – [**Normal**], [Bi-Directional], [ECP], [EPP], or [ECP & EPP]
 - * If [Normal] is selected, the standard parallel port mode is used. This is the default setting.
 - * If [Bi-Directional] is selected, the data is sent to and received from the parallel port.
 - * If [ECP] is selected, the ECP Mode DMA Channel appears below. The ECP parallel port can be used with devices adhering to the Extended Capabilities Port (ECP) specification. ECP uses the DMA protocol to achieve data transfer rates up to 2.5 Megabits per second. ECP also provides symmetric bi-directional communication.
 - ECP Mode DMA Channel – [DMA0], [DMA1], or [**DMA3**]
 - * If [EPP] is selected, the EPP Version appears below. The EPP parallel port can be used with devices adhering to the Enhanced Parallel Port (EPP) specification. EPP uses the existing parallel port signals to provide asymmetric bi-directional data transfer driven by the host device.
 - EPP Version – [**1.9**] or [1.7]
 - * If [ECP & EPP] is selected, all of the options for both appear below Parallel Port Mode.
- ◆ Parallel Port 2 IRQ – [**IRQ5**] or [IRQ 7]

>Clock Configuration

- Spread Spectrum – [**Disabled**] or [Enabled]

This field supports the LVDS interface with Spread Spectrum Clocking (SSC) and enables clock modulation to reduce EMI.

>IDE Configuration

- ATE/IDE Configuration – [Disabled], [**Compatible**], or [Enhanced]

This field configures the integrated parallel and serial ATA controllers on the XTX 820.

- * If this field is set to [Disabled], both integrated parallel and serial ATA controllers onboard the XTX 820 are prevented from operating and all IDE device fields below *Legacy IDE Channels* disappear from the screen.
- * If this field is set to [Compatible], both integrated parallel and serial ATA controllers operate in legacy or compatible mode.
- * If this field is set to [Enhanced], both integrated parallel and serial ATA controllers operate in enhanced or native mode and the next field, *Legacy IDE Channels*, disappears from the screen.

- ◆ Legacy IDE Channels – [SATA Only], [**SATA Pri, PATA Sec**], or [PATA Only]

This field determines which IDE channels are used to attach the Serial ATA (SATA) and Parallel ATA (PATA or EIDE HDDs) drives in BIOS Setup.

- * If this field is set to [SATA Only], only the SATA (Serial ATA) drives can be attached to the system and recognized by the BIOS.
- * If this field is set to [SATA Pri, PATA Sec], the SATA drives are attached to the Primary IDE channel and the EIDE hard disk drives (PATA) are attached to the Secondary IDE channel.
- * If this field is set to [PATA Only], only the EIDE hard disk drives (PATA) can be attached to the system and recognized by the BIOS.

>Primary IDE Master: – [Not Detected] or [Device Type]

- * If the BIOS does not detect a device on the Primary IDE Master channel, [Not Detected] will be displayed. You can still go to the submenu to set options for an IDE device.
- * If the BIOS auto detects a IDE device, the device will be displayed [Hard Disk for example] with the parameters automatically selected, because auto is used for the defaults.
- ◆ Type – [Not Installed], [**Auto**], [CD/DVD], or [ARMD]

This field sets the type of device the BIOS attempts to boot from after the Power On Self Test (POST) has completed.

- * If [Not Installed] is selected, the BIOS is prevented from searching for an IDE disk drive on the specified channel.
- * If [Auto] is selected, the BIOS auto detects any IDE disk drives on the specified channel. This is the default setting and should be used for any IDE hard disk drive attached to the baseboard.
- * If [CD/DVD] is selected, the BIOS only searches for an IDE CD-ROM or IDE DVD device on the Primary IDE channel. The BIOS will not attempt to search for other types of IDE devices on the specified channel.
- * If [ARMD] is selected, the BIOS detects an ATAPI Removable Media Device on the specified IDE channel. This includes, but is not limited to ZIP drives and LS-120 drives.

- ◆ LBA/Large Mode – [Disabled] or [**Auto**]

This field sets the LBA (Logical Block Addressing) on the IDE disk drive. In LBA mode with a setting of [**Auto**], the maximum drive capacity is greater than 137 GB.

- ◆ Block (Multi-Sector Transfer) – [Disabled] or [**Auto**]

This field sets the block mode multi-sector transfers option and allows the BIOS to auto detect device support for Multi-Sector Transfers on the specified channel. Block mode boosts IDE drive performance by increasing the amount of data transferred. Only 512 bytes of data can be transferred per interrupt if block mode is not used. Block mode allows transfers of up to 64 kB per interrupt.

- * If [Auto] is selected, the BIOS will auto detect the number of sectors per block for transfer from the hard disk drive to the memory. The data transfer to and from the device will occur multiple sectors at a time.

◆ PIO Mode – [Auto], [0], [1], [2], [3], or [4]

This field sets the IDE PIO (Programmable I/O) mode and programs the timing cycles between the IDE drive and the programmable IDE controller. As the PIO mode increases, the cycle time decreases.

- * If [Auto] is selected, the BIOS auto detects the PIO mode.
- * If [0] is selected, the BIOS uses PIO mode 0, with a data transfer rate of 3.3 MBs.
- * If [1] is selected, the BIOS uses PIO mode 1, with a data transfer rate of 5.2 MBs.
- * If [2] is selected, the BIOS uses PIO mode 2, with a data transfer rate of 8.3 MBs.
- * If [3] is selected, the BIOS uses PIO mode 3, with a data transfer rate of 11.1 MBs.
- * If [4] is selected, the BIOS uses PIO mode 4, with a data transfer rate of 16.6 MBs.

◆ DMA Mode – [Auto], [SWDMA0], [SWDMA01], [SWDMA2], [MWDMA0], [MWDMA1], [MWDMA2], [UDMA0], [UDMA1], [UDMA2], [UDMA3], [UDMA4], [UDMA5], or [UDMA6]

This field allows you to select DMA modes and adjust the respective transfer rate. The list of available DMA modes are dependent on the IDE device and its supported modes, including the transfer speed and cable type (40-pin or 80-pin).

- * If [Auto] is selected, the BIOS auto detects the DMA Mode. Use this value if the IDE disk drive support cannot be determined.
- * If [SWDMA0] is selected, the BIOS uses Single Word DMA mode 0, with a data transfer rate of 2.1 MBs.
- * If [SWDMA1] is selected, the BIOS uses Single Word DMA mode 1, with a data transfer rate of 4.2 MBs.
- * If [SWDMA2] is selected, the BIOS uses Single Word DMA mode 2, with a data transfer rate of 8.3 MBs.
- * If [MWDMA0] is selected, the BIOS uses Double Word DMA mode 0, with a data transfer rate of 4.2 MBs.
- * If [MWDMA1] is selected, the BIOS uses Double Word DMA mode 1, with a data transfer rate of 13.3 MBs.
- * If [MWDMA2] is selected, the BIOS uses Double Word DMA mode 2, with a data transfer rate of 16.6 MBs.
- * If [UDMA0] is selected, the BIOS uses Ultra DMA mode 0, with a data transfer rate of 16.6 MBs.
- * If [UDMA1] is selected, the BIOS uses Ultra DMA mode 1, with a data transfer rate of 25 MBs.
- * If [UDMA2] is selected, the BIOS uses Ultra DMA mode 2, with a data transfer rate of 33.3 MBs.

NOTE

If you select UDMA3, UDMA4, UDMA5, or UDMA6, an 80-conductor ATA cable is required.

- * If [UDMA3] is selected, the BIOS uses Ultra DMA mode 3, with a data transfer rate of 44.4 MBs. To use this mode, an 80-conductor ATA cable is required.
- * If [UDMA4] is selected, the BIOS uses Ultra DMA mode 4, with a data transfer rate of 66.6 MBs. To use this mode, an 80-conductor ATA cable is required.

- * If [UDMA5] is selected, the BIOS uses Ultra DMA mode 5, with a data transfer rate of 99.9 MBs. To use this mode, an 80-conductor ATA cable is required.
- * If [UDMA6] is selected, the BIOS uses Ultra DMA mode 6, with a data transfer rate of 133.2 MBs. To use this mode, an 80-conductor ATA cable is required.

◆ S.M.A.R.T. – [**Auto**], [Disabled], or [Enabled]

The Self-Monitoring Analysis and Reporting Technology (SMART) feature can help predict impending drive failures.

- * If [Auto] is selected, the BIOS auto detects hard disk drive support. Use this setting if the IDE disk drive support cannot be determined.
- * If [Disabled] is selected, the BIOS is prevented from using SMART feature.
- * If [Enabled] is selected, the BIOS uses the SMART feature on the hard disk drives.

◆ 32Bit Data Transfer – [Disabled] or [**Enabled**]

This field sets the 32-bit data transfer rate.

- * If [Enabled] is selected, the BIOS uses 32-bit data transfers on the supported hard disk drive.

>**Primary IDE Slave:** – [**Not Detected**] or [Device Type]

The descriptions used for the Primary IDE Master are the same for the Primary IDE Slave except where noted.

- * If the BIOS does not detect a device on the Primary IDE Slave channel [Not Detected] will be displayed. You can still go to the submenu to set options for an IDE device.
- * If the BIOS auto detects a IDE device, the device will be displayed [Hard Disk for example] with the parameters automatically selected.
- ◆ Type – [Not Installed], [**Auto**], [CD/DVD], or [ARMD]
 - * If [Not Installed] appears due to Not Detected, the balance of the options for Primary IDE Slave may not appear on screen.
- ◆ LBA/Large Mode – [Disabled] or [**Auto**]
- ◆ Block (Multi-Sector Transfer) – [Disabled] or [**Auto**]
- ◆ PIO Mode – [**Auto**], [0], [1], [2], [3], or [4]
- ◆ DMA Mode – [**Auto**], [SWDMA0], [SWDMA01], [SWDMA2], [MWDMA0], [MWDMA1], [MWDMA2], [UDMA0], [UDMA1], [UDMA2], [UDMA3], [UDMA4], [UDMA5], or [UDMA6]
- ◆ S.M.A.R.T. – [**Auto**], [Disabled], or [Enabled]
- ◆ 32Bit Data Transfer – [Disabled] or [**Enabled**]

>**Secondary IDE Master:** – [**Not Detected**] or [Device Type]

The descriptions used for the Primary IDE Master are the same for the Secondary IDE Master except where noted.

- * If the BIOS does not detect a device on the Secondary IDE Master channel [Not Detected] will be displayed. You can still go to the submenu to set options for an IDE device.
- * If the BIOS auto detects a IDE device, the device will be displayed [Hard Disk for example] with the parameters automatically selected.
- ◆ Type – [Not Installed], [**Auto**], [CD/DVD], or [ARMD]
 - * If [Not Installed] appears due to Not Detected, the balance of the options for Secondary IDE Master may not appear on screen.

- ◆ LBA/Large Mode – [Disabled] or [**Auto**]
- ◆ Block (Multi-Sector Transfer) – [Disabled] or [**Auto**]
- ◆ PIO Mode – [**Auto**], [0], [1], [2], [3], or [4]
- ◆ DMA Mode – [**Auto**], [SWDMA0], [SWDMA01], [SWDMA2], [MWDMA0], [MWDMA1], [MWDMA2], [UDMA0], [UDMA1], [UDMA2], [UDMA3], [UDMA4], [UDMA5], or [UDMA6]
- ◆ S.M.A.R.T. – [**Auto**], [Disabled], or [Enabled]
- ◆ 32Bit Data Transfer – [Disabled] or [**Enabled**]

>**Secondary IDE Slave:** – [**Not Detected**] or [Device Type]

The descriptions used for the Primary IDE Master are the same for the Secondary IDE Slave except where noted.

* If the BIOS does not detect a device on the Secondary IDE Slave channel [Not Detected] will be displayed. You can still go to the submenu to set options for an IDE device.

* If the BIOS auto detects a IDE device, the device will be displayed [Hard Disk for example] with the parameters automatically selected.

- ◆ Type – [Not Installed], [**Auto**], [CD/DVD], or [ARMD]
 - * If [Not Installed] appears due to Not Detected, the balance of the options for Secondary IDE Slave may not appear on screen.
- ◆ LBA/Large Mode – [Disabled] or [**Auto**]
- ◆ Block (Multi-Sector Transfer) – [Disabled] or [**Auto**]
- ◆ PIO Mode – [**Auto**], [0], [1], [2], [3], or [4]
- ◆ DMA Mode – [**Auto**], [SWDMA0], [SWDMA01], [SWDMA2], [MWDMA0], [MWDMA1], [MWDMA2], [UDMA0], [UDMA1], [UDMA2], [UDMA3], [UDMA4], [UDMA5], or [UDMA6]
- ◆ S.M.A.R.T. – [**Auto**], [Disabled], or [Enabled]
- ◆ 32Bit Data Transfer – [Disabled] or [**Enabled**]

>**Third IDE Master:** – [**Not Detected**] or [Device Type]

The descriptions used for the Primary IDE Master are the same for the Third IDE Master except where noted.

* If the BIOS does not detect a device on the Third IDE Master channel [Not Detected] will be displayed. You can still go to the submenu to set options for an IDE device.

* If the BIOS auto detects a IDE device, the device will be displayed [Hard Disk for example] with the parameters automatically selected.

- ◆ Type – [Not Installed], [**Auto**], [CD/DVD], or [ARMD]
 - * If [Not Installed] appears due to Not Detected, the balance of the options for Third IDE Master may not appear on screen.
- ◆ LBA/Large Mode – [Disabled] or [**Auto**]
- ◆ Block (Multi-Sector Transfer) – [Disabled] or [**Auto**]
- ◆ PIO Mode – [**Auto**], [0], [1], [2], [3], or [4]
- ◆ DMA Mode – [**Auto**], [SWDMA0], [SWDMA01], [SWDMA2], [MWDMA0], [MWDMA1], [MWDMA2], [UDMA0], [UDMA1], [UDMA2], [UDMA3], [UDMA4], [UDMA5], or [UDMA6]

- ◆ S.M.A.R.T. – [**Auto**], [Disabled], or [Enabled]
- ◆ 32Bit Data Transfer – [Disabled] or [**Enabled**]

> **Third IDE Slave:** – [**Not Detected**] or [Device Type]

The descriptions used for the Primary IDE Master are the same for the Third IDE Slave except where noted.

- * If the BIOS does not detect a device on the Third IDE Slave channel, [Not Detected] will be displayed. You can still go to the submenu to set options for an IDE device.
- * If the BIOS auto detects a IDE device, the device will be displayed [Hard Disk for example] with the parameters automatically selected.
 - ◆ Type – [Not Installed], [**Auto**], [CD/DVD], or [ARMD]
 - * If [Not Installed] appears due to Not Detected, the balance of the options for Third IDE Slave may not appear on screen.
 - ◆ LBA/Large Mode – [Disabled] or [**Auto**]
 - ◆ Block (Multi-Sector Transfer) – [Disabled] or [**Auto**]
 - ◆ PIO Mode – [**Auto**], [0], [1], [2], [3], or [4]
 - ◆ DMA Mode – [**Auto**], [SWDMA0], [SWDMA01], [SWDMA2], [MWDMA0], [MWDMA1], [MWDMA2], [UDMA0], [UDMA1], [UDMA2], [UDMA3], [UDMA4], [UDMA5], or [UDMA6]
 - ◆ S.M.A.R.T. – [**Auto**], [Disabled], or [Enabled]
 - ◆ 32Bit Data Transfer – [Disabled] or [**Enabled**]
- Hard Disk Write Protect – [**Disabled**] or [Enabled]

> **Fourth IDE Master:** – [**Not Detected**] or [Device Type]

The descriptions used for the Primary IDE Master are the same for the Fourth IDE Master except where noted.

- * If the BIOS does not detect a device on the Fourth IDE Master channel, [Not Detected] will be displayed. You can still go to the submenu to set options for an IDE device.
- * If the BIOS auto detects a IDE device, the device will be displayed [Hard Disk for example] with the parameters automatically selected.
 - ◆ Type – [Not Installed], [**Auto**], [CD/DVD], or [ARMD]
 - * If [Not Installed] appears due to Not Detected, the balance of the options for Fourth IDE Master may not appear on screen.
 - ◆ LBA/Large Mode – [Disabled] or [**Auto**]
 - ◆ Block (Multi-Sector Transfer) – [Disabled] or [**Auto**]
 - ◆ PIO Mode – [**Auto**], [0], [1], [2], [3], or [4]
 - ◆ DMA Mode – [**Auto**], [SWDMA0], [SWDMA01], [SWDMA2], [MWDMA0], [MWDMA1], [MWDMA2], [UDMA0], [UDMA1], [UDMA2], [UDMA3], [UDMA4], [UDMA5], or [UDMA6]
 - ◆ S.M.A.R.T. – [**Auto**], [Disabled], or [Enabled]
 - ◆ 32Bit Data Transfer – [Disabled] or [**Enabled**]

> **Fourth IDE Slave:** – [Not Detected] or [Device Type]

The descriptions used for the Primary IDE Master are the same for the Fourth IDE Slave except where noted.

- * If the BIOS does not detect a device on the Fourth IDE Slave channel [Not Detected] will be displayed. You can still go to the submenu to set options for an IDE device.
- * If the BIOS auto detects a IDE device, the device will be displayed [Hard Disk for example] with the parameters automatically selected.
 - ◆ Type – [Not Installed], [**Auto**], [CD/DVD], or [ARMD]
 - * If [Not Installed] appears due to Not Detected, the balance of the options for Fourth IDE Slave may not appear on screen.
 - ◆ LBA/Large Mode – [Disabled] or [**Auto**]
 - ◆ Block (Multi-Sector Transfer) – [Disabled] or [**Auto**]
 - ◆ PIO Mode – [**Auto**], [0], [1], [2], [3], or [4]
 - ◆ DMA Mode – [**Auto**], [SWDMA0], [SWDMA01], [SWDMA2], [MWDMA0], [MWDMA1], [MWDMA2], [UDMA0], [UDMA1], [UDMA2], [UDMA3], [UDMA4], [UDMA5], or [UDMA6]
 - ◆ S.M.A.R.T. – [**Auto**], [Disabled], or [Enabled]
 - ◆ 32Bit Data Transfer – [Disabled] or [**Enabled**]
- Hard Disk Write Protect – [**Disabled**] or [Enabled]

This field protects the hard disk drive from being overwritten.

 - * If [Disabled] is selected, the HDD operates normally, allowing Read, Write, and Erase functions to be performed on the IDE hard disk drive.
 - * If [Enabled] is selected, the BIOS is prevents the IDE HDD from being erased.
- IDE Detect Time Out (Sec) – [0], [5], [10], [15], [20], [25], [30], or [**35**]

The field determines how long the BIOS searches for the available IDE devices on the specified channels. Some IDE HDDs take the BIOS longer to locate than others, but this field allows you fine-tune the settings to allow for faster boot times.

 - * If [0] is selected, the BIOS does not search for an IDE device. This is the best setting to use if the onboard IDE controllers are set to a specific IDE HDD in the BIOS.
 - * If [5] is selected, the BIOS stops searching for an IDE device after 5 seconds. A large majority of ultra ATA HDDs can be detected with within 5 seconds.
 - * If [10] is selected, the BIOS stops searching for an IDE device after 10 seconds.
 - * If [15] is selected, the BIOS stops searching for an IDE device after 15 seconds.
 - * If [20] is selected, the BIOS stops searching for an IDE device after 20 seconds.
 - * If [25] is selected, the BIOS stops searching for an IDE device after 25 seconds.
 - * If [30] is selected, the BIOS stops searching for an IDE device after 30 seconds.
 - * If [35] is selected, the BIOS stops searching for an IDE device after 35 seconds. This is the default setting and is the recommended setting when all IDE connectors are set to Auto.

- ATA (PI) 80 Pin Cable Detection – [**Host & Device**], [Host], or [Device]

This field selects the method used to detect the ATA (PI) 80-pin cable.

- * If [Host & Device] is selected, the BIOS uses both the onboard IDE controller and the IDE hard disk drive (HDD) to detect the type of IDE cable used.
- * If [Host] is selected, the BIOS uses only the onboard IDE controller to detect the type of IDE cable used.
- * If [Device] is selected, the BIOS uses only the IDE hard disk drive (HDD) to detect the type of IDE cable used.

NOTE	An 80-conductor ATA cable is required when operating with Ultra ATA/66, Ultra ATA/100 and Ultra ATA/133 IDE hard disk drives. The standard 40-conductor ATA cable cannot handle the higher speeds. Due to the plug compatibility of the 80-conductor ATA cable to the standard 40-conductor ATA cable, the BIOS must have a feature to set this or determine if the 80-conductor ATA cable is present. The BIOS does this by searching for a break (open) in one of the lines in the 80-conductor ATA cable that is normally connected in the standard 40-conductor ATA cable. If a faster speed is set in the BIOS than the connected cable can support, the BIOS instructs the IDE HDD to run at the correct (or slower) speed for the cable type detected.
-------------	---

>USB Configuration

Depending on the USB devices detected, examples similar to those listed below may be displayed.

Module Version - x.xx.xx-xx.x

Or

Module Version - x.xx.xx-xx.x

**USB Devices Enabled:
2 Drives**

**USB Devices Enabled:
None:**

- USB Function – [Disabled], [2 USB ports], [4 USB ports], or [**6 USB ports**]
- USB 2.0 Controller – [Disabled] or [**Enabled**]
- Legacy USB Support – [Disabled], [**Enabled**], or [Auto]

This field supports the USB mouse and USB keyboard when no USB drivers are loaded for the operating system (OS). If this option is not enabled, the attached USB mouse and USB keyboard will not be available until a USB compatible OS is fully booted with all the USB drivers loaded.

CAUTION	If this field is not set to [Enabled] or [Auto] the USB mouse and USB keyboard will not be recognized by the BIOS until the OS is fully booted and the USB drivers are loaded.
----------------	--

- * If [Enabled] is selected, USB devices may be used during boot time and while using DOS.
- * If [Auto] is selected, USB devices, such as a USB keyboard or USB mouse will be automatically detected and if found, will be initialized and utilized during Boot time.
- USB Keyboard Legacy Support – [Disabled] or [**Enabled**]
- USB Mouse Legacy Support – [Disabled] or [**Enabled**]
- USB Storage Device Support – [Disabled] or [**Enabled**]
- Port 64/60 Emulation – [**Disabled**] or [Enabled]
 - * If this field is set to [Enabled], it allows the BIOS to provide full PS/2 based legacy support for USB keyboard and mouse. It provides the PS/2 functionality such as keyboard lock, password setting, scan code selection etc. to USB keyboards.

- USB 2.0 Controller Mode – [Full Speed] or [**Hi Speed**]
This field configures the USB 2.0 controller for [Full Speed = 12 Mbps] or [Hi Speed = 480 Mbps]
- BIOS EHCI Hand-Off – [Disabled] or [**Enabled**]
This field is used as work around for operating systems (OSs) that do not have EHCI hand-off support. The EHCI ownership change should be claimed by the EHCI driver.
- USB Beep Message – [Disabled] or [**Enabled**]
* If this field is set to [**Enabled**], the BIOS issues a beep signal each time a USB device is found and initialized during the boot sequence.
- USB Stick Default Emulation – [Auto] or [**Hard Disk**]
Use this field to select the (default) USB memory stick emulation type.
 - * If [Auto] is selected, the BIOS selects FDD or HDD emulation based on the storage size of the memory stick. The emulation type can be manually reconfigured for each device using the Mass Storage Device Configuration submenu. However, if [Auto] has not been selected, the USB MASS Storage Device Configuration menu selection will not appear on screen, which will not allow you to change the emulation type.
 - * If [Hard Disk] is selected, the USB memory stick will use hard disk drive (HDD) emulation.
- USB Mass Storage Reset Delay – [10 sec], [**20 sec**], [30 sec], or [40 sec]
This field determines the number of seconds POST waits after issuing a reset (start unit command) to the USB mass storage device.

>USB MASS Storage Device Configuration

This field and all subsequent USB fields only appear on screen if **USB Stick Default Emulation** is set to [*Auto*].

Every USB Mass Storage Device (MSD) recognized by the BIOS will have an emulation type setup field. This field specifies the type of emulation the BIOS provides for the device.

CAUTION To prevent USB boot problems, ensure you match the USB mass storage device's formatted type and the emulation type provided by the BIOS to boot properly.

- ◆ Device #1 – [Mfg + model] or [USB2.0 device type]
- ◆ Emulation Type – [**Auto**], [Floppy], [Forced FDD], [Hard Disk], or [CDROM]
This field allows you to override or manually set the USB emulation device type for USB Device #1, listed above.
 - * If this field is set to [Auto], the BIOS will emulate USB devices less than 530 MB as Floppy and devices larger than 530 MB as Hard Drives.
 - * If this field is set to [Floppy], the BIOS will emulate the device as a floppy drive.
 - * If this field is set to [Forced FDD], the BIOS will force the HDD formatted drive to be emulated as FDD (except ZIP drives). This only functions for hard drives formatted with FAT12, FAT16, or FAT32.
 - * If this field is set to [Hard Disk], the USB device is emulated as a hard disk drive.
 - * If this field is set to [CDROM], the BIOS assumes the device (CD-ROM) is formatted as a bootable media, specified by the 'El Torito' Format Specification.

The remaining fields listed below only appear if the BIOS detects additional USB mass storage devices up to five more USB devices.

- ◆ Device #2 – [Mfg + model] or [USB2.0 device type]
- ◆ Emulation Type – [**Auto**], [Floppy], [Forced FDD], [Hard Disk], or [CDROM]
- ◆ Device #3 – [Mfg + model] or [USB2.0 device type]
- ◆ Emulation Type – [**Auto**], [Floppy], [Forced FDD], [Hard Disk], or [CDROM]
- ◆ Device #4 – [Mfg + model] or [USB2.0 device type]
- ◆ Emulation Type – [**Auto**], [Floppy], [Forced FDD], [Hard Disk], or [CDROM]
- ◆ Device #5 – [Mfg + model] or [USB2.0 device type]
- ◆ Emulation Type – [**Auto**], [Floppy], [Forced FDD], [Hard Disk], or [CDROM]
- ◆ Device #6 – [Mfg + model] or [USB2.0 device type]
- ◆ Emulation Type – [**Auto**], [Floppy], [Forced FDD], [Hard Disk], or [CDROM]

>Keyboard/Mouse Configuration

- Bootup Num-Lock – [Off] or [**On**]

This field enables or disables the Num-Lock (Number Lock) keypad, including the 10-key numeric keys, to be turned on or off automatically when the system boots up. The field selection will remain unchanged until the Num-Lock key on the keyboard is pressed to change the Num-Lock state.

- Typematic Rate – [Slow] or [**Fast**]
- PS/2 Mouse Support – [Disabled], [Enabled], or [**Auto**]
 - * If [Disabled] is selected, the PS/2 Mouse will not have access to system resources and will not be active after boot up.
 - * If [Enabled] is selected, the PS/2 Mouse can be used and will have access to system resources after boot up.
 - * If [Auto] is selected, the BIOS will detect the PS/2 Mouse automatically, if present, during the boot process. The PS/2 Mouse will have access to system resources and be active after boot up.

>Remote Access Configuration (Serial Console or Console Redirection)

- Remote Access – [**Disabled**] or [Enabled]

This field enables Remote access (Serial Console or Console Redirection) through one of the serial ports to a remote serial terminal. If this field is set to [Disabled], none of the supporting features are listed on screen.

- ◆ Serial Port Number – [**COM1**] or [COM2]

Base Address, IRQ [3F8h, 4]
- ◆ Serial Port Mode – [**115200, 8, n, 1**], [57600, 8, n, 1], [38400, 8, n, 1], [19200, 8, n, 1], or [09600, 8, n, 1]
 - * If [57600, 8, n, 1] is selected, the remote access operates at 57.6 kHz baud rate and there are 8 start bits, no parity, and 1 stop bit used.
- ◆ Flow Control – [**None**], [Hardware], or [Software]
- ◆ Redirection After BIOS Post – [Disabled], [Boot Loader], or [**Always**]
 - * If this field is set to [Disabled], the Serial Redirection function is disabled at the end of BIOS POST.

- * If this field is set to [Always], all resources and interrupts associated with Serial Redirection are protected and not released to DOS. This option lets Serial Redirection permanently reside at base memory which allows the DOS console to be redirected. However, the graphics output (VGA, SVGA, etc) from DOS programs is not redirected.
- * If this field is set to [Boot Loader], Serial Redirection is active during the OS boot loader process. This allows boot status messages to be redirected, but Serial Redirection will terminate when the OS loads.
- ◆ Terminal Type – [ANSI], [VT100], or [VT-UTF8]
 - * If [VT-UTF8] is selected, the following field disappears from the screen.
 - VT-UTF8 Combo Key Support – [Disabled] or [Enabled]

This field enables VT-UFT8 combination key support for ANSI/VT100 terminals.
- ◆ Sredir Memory Display Delay – [No Delay], [Delay 1 sec], [Delay 2 sec] or [Delay 4 sec]

This fields sets the delay in seconds for the memory information to display on screen.

>Hardware Health Configuration

- H/W Health Function – [Disabled] or [Enabled]

Hardware Health Event Monitoring

- ◆ Board Temperature – [Current board temperature °C/°F]
- ◆ CPU Temperature – [Current processor die temperature °C/°F]
- ◆ VcoreA – [Current Core A reading]
- ◆ VcoreB – [Current Core B reading]
- ◆ +3.3Vin – [Current +3.3V reading]
- ◆ +5Vin – [Current +5V reading]
- ◆ VBAT – [Current VBAT (≈3.0V) reading]

>Watchdog Configuration

- Post Watchdog – [Disabled], [30 sec], [1 min], [2 min], [5 min], [10 min], or [30 min]

This watchdog is only active during the power-on-self-test (POST) of the system and provides a facility to prevent errors during bootup by performing a reset.

 - * If this field is enabled by selecting a time interval (30 sec to 30 min) it will direct the watchdog timer to reset the system if it fails to boot the OS properly. Refer to the watchdog timer section in Chapter 3 for more information.
- Runtime Watchdog – [Disabled], [One-time trigger], [Single Event], or [Repeated Event]

This field selects the operating mode of the runtime watchdog and will be initialized just before the operating system starts booting.

 - * If this field is set to [One time trigger], the watchdog will be disabled after the first trigger.
 - * If this field is set to [Single event', every stage will be executed only once, then the watchdog will be disabled.
 - * If this field is set to [Repeated event] the last stage will be executed repeatedly until a reset occurs.
 - * If [Disabled] is selected the following options do not appear on screen.
- ◆ Delay – [Disabled], [10 sec], [30 sec], [1 min], [2 min], [5 min], [10 min], or [30 min]

This field selects the delay time before the runtime watchdog becomes active. This ensures the operating system has enough time to load.

- ◆ Event 1 – [NMI], [ACPI Event], [Reset], or [Power Button]
This field selects the type of event that will be generated when timeout 1 is reached.
- ◆ Event 2 – [Disabled], [NMI], [ACPI Event], [Reset], or [Power Button]
This field selects the type of event that will be generated when timeout 2 is reached.
- ◆ Event 3 – [Disabled], [NMI], [ACPI Event], [Reset], or [Power Button]
This field selects the type of event that will be generated when timeout 3 is reached.
- ◆ Timeout 1 – [0.5 sec], [1 sec], [2 sec], [5 sec], [10 sec], [30 sec] [1 min], or [2 min]
This field selects the timeout value for the first stage watchdog event.
- ◆ Timeout 2 – [0.5 sec], [1 sec], [2 sec], [5 sec], [10 sec], [30 sec] [1 min], or [2 min]
These fields select the timeout value for the second and third stage watchdog events.
- ◆ Timeout 3 – [0.5 sec], [1 sec], [2 sec], [5 sec], [10 sec], [30 sec] [1 min], or [2 min]

BIOS Boot Setup Screen

BIOS Setup Utility					
Main	Advanced	Boot	Security	Power	Exit
Boot Priority Selection		[Type Base]	The device based boot priority list allows to select from a list of currently detected devices. The type based boot priority list allows to select device types even if a respective device is not (yet) present. Select Screen Select Item + - Change Option F1 General Help F10 Save and Exit ESC Exit		
Boot Device Priority					
1st Boot Device		[USB Floppy]			
2nd Boot Device		[USB Removable Devi]			
3rd Boot Device		[USB Harddisk]			
4th Boot Device		[Onboard LAN]			
5th Boot Device		[Primary Master]			
6th Boot Device		[Primary Slave]			
7th Boot Device		[Secondary Master]			
8th Boot Device		[Secondary Slave]			
Boot Settings Configuration					
Quick Boot		[Enabled]			
Quiet Boot		[Disabled]			
AddOn ROM Display Mode		[Force BIOS]			
Automatic Boot List Retry		[Disabled]			
Halt On Error		[Disabled]			

V02.xx (C) Copyright 1985-2004, American Megatrends, Inc.

Figure 4-3. BIOS Boot Setup Screen

Boot Priority Selection – [Device Based] or [Type Based]

Use these fields to set the boot priority, which determines the sequence the BIOS uses when checking for a boot device.

- * If [Device Based] boot priority is selected, you can select from the list of currently detected devices. The BIOS auto detects any devices that may be connected to the XTX 820 and baseboard assembly, and will list the devices found including the Mfg and model.
- * If [Type Based] boot priority is selected, you can select device types from a device list even if the respective device is not connected yet.

Boot Device Priority

Use these fields to set the boot priority, which determines the sequence the BIOS checks for a boot device. A BEV (Boot Entry Vector) device (Network or SCSI option-ROMs) can be used to boot the system.

- ◆ 1st Boot Device – [Disabled], [Primary Master], [Primary Slave], [Secondary Master], [Secondary Slave], [Legacy Floppy], [**USB Floppy**], [USB Harddisk], [USB CDROM], [USB Removable Device], [Onboard LAN], [External LAN], [PCI Mass Storage], [PCI SCSI Card], [Any PCI BEV Device], [Third Master], or [Third Slave]
- ◆ 2nd Boot Device – [Disabled], [Primary Master], [Primary Slave], [Secondary Master], [Secondary Slave], [Legacy Floppy], [USB Floppy], [USB Harddisk], [USB CDROM], [**USB Removable Device**], [Onboard LAN], [External LAN], [PCI Mass Storage], [PCI SCSI Card], [Any PCI BEV Device], [Third Master], or [Third Slave]
- ◆ 3rd Boot Device – [Disabled], [Primary Master], [Primary Slave], [Secondary Master], [Secondary Slave], [Legacy Floppy], [USB Floppy], [**USB Harddisk**], [USB CDROM], [USB Removable Device], [Onboard LAN], [External LAN], [PCI Mass Storage], [PCI SCSI Card], [Any PCI BEV Device], [Third Master], or [Third Slave]

- ◆ 4th Boot Device – [Disabled], [Primary Master], [Primary Slave], [Secondary Master], [Secondary Slave], [Legacy Floppy], [USB Floppy], [USB Harddisk], [USB CDROM], [USB Removable Device], [**Onboard LAN**], [External LAN], [PCI Mass Storage], [PCI SCSI Card], [Any PCI BEV Device], [Third Master], or [Third Slave]
- ◆ 5th Boot Device – [Disabled], [**Primary Master**], [Primary Slave], [Secondary Master], [Secondary Slave], [Legacy Floppy], [USB Floppy], [USB Harddisk], [USB CDROM], [USB Removable Device], [Onboard LAN], [External LAN], [PCI Mass Storage], [PCI SCSI Card], [Any PCI BEV Device], [Third Master], or [Third Slave]
- ◆ 6th Boot Device – [Disabled], [Primary Master], [**Primary Slave**], [Secondary Master], [Secondary Slave], [Legacy Floppy], [USB Floppy], [USB Harddisk], [USB CDROM], [USB Removable Device], [Onboard LAN], [External LAN], [PCI Mass Storage], [PCI SCSI Card], [Any PCI BEV Device], [Third Master], or [Third Slave]
- ◆ 7th Boot Device – [Disabled], [Primary Master], [Primary Slave], [**Secondary Master**], [Secondary Slave], [Legacy Floppy], [USB Floppy], [USB Harddisk], [USB CDROM], [USB Removable Device], [Onboard LAN], [External LAN], [PCI Mass Storage], [PCI SCSI Card], [Any PCI BEV Device], [Third Master], or [Third Slave]
- ◆ 8th Boot Device – [Disabled], [Primary Master], [Primary Slave], [Secondary Master], [**Secondary Slave**], [Legacy Floppy], [USB Floppy], [USB Harddisk], [USB CDROM], [USB Removable Device], [Onboard LAN], [External LAN], [PCI Mass Storage], [PCI SCSI Card], [Any PCI BEV Device], [Third Master], or [Third Slave]

Boot Settings Configuration

- Quick Boot – [Disabled] or [**Enabled**]
 - * If [Disabled] is selected, the BIOS is allowed to perform all POST test, but this slows the boot process.
 - * If [Enabled] is selected, the BIOS is allowed to skip certain POST tests to boot faster.
- Quiet Boot – [**Disabled**] or [Enabled]
 - * If [Disabled] is selected, the BIOS displays normal POST messages on screen.
 - * If [Enabled] is selected, the BIOS displays the customized splash screen (OEM logo) on screen. The splash screen image (or OEM boot logo) will appear on the display instead of the POST messages.

For more information about how to customized a splash screen (OEM boot logo), refer to the System Utility and the *System Utility Users Guide* located on the XTX 820 Doc & SW CD-ROM in the System Tools and Documentation directory under *Software*.
- ◆ Boot Display – [**Clear**] or [Maintain]

The Boot Display field only appears on screen when the Quiet Boot is set to [Enabled]. The boot display field controls the end of the POST boot display and how it is handled.

 - * If Boot Display is set to [Clear], the BIOS will clear the screen and switch to VGA text mode.
 - * If Boot Display is set to [Maintain], the BIOS will maintain the current display contents and graphics video used for POST display.
- Automatic Boot List Retry – [**Disabled**] or [Enabled]
- AddOn ROM Display Mode – [Force BIOS] or [**Keep Current**]
 - * If [Force BIOS] is selected, any third party BIOS or add-on ROM messages will be displayed on screen during the boot process.
 - * If [Keep Current] is selected, no third party BIOS messages will be displayed on screen during the boot process.

- Halt On Error – [**Disabled**] or [Enabled]
 - * If [Disabled] is selected, this does not allow for user intervention if an error occurs. Use this setting only when a known BIOS error will appear.
 - * If [Enabled] is selected, allows the BIOS to display an Error message indicating when an error has occurred during POST (power on self test) and wait for you to respond by hitting the <F1> key. Pressing <F1> will enter Setup and the BIOS setting can be adjusted to fix the problem.
- Hit 'DEL' Message Display – [Disabled] or [**Enabled**]
 - * If [Disabled] is selected, the BIOS will not place the “Hit Del to enter Setup” message on screen during the boot process. If Quiet Boot is enabled, the Hit 'Del" message will not display.
 - * If [Enabled] is selected, the BIOS will place the “Hit Del to enter Setup” message on screen during the boot process, to indicate when you may press “Del” to enter the BIOS Setup menus.
- Interrupt 19 Capture – [**Disabled**] or [Enabled]
 - * If [Disabled] is selected, the BIOS prevents option ROMs from trapping interrupt 19.
 - * If [Enabled] is selected, allows option ROMs to trap interrupt 19.
- PXE Boot to LAN – [**Disabled**] or [Enabled]

Use this field to turn on the LAN Boot feature. You will also need to reboot the system to see the Intel Boot Agent device [Onboard LAN or Network: IBA...] in the Boot Device Priority Menu, so it can be moved to the top of the boot order. Refer to Appendix B, *LAN Boot Feature* for more information.
- Power Loss Control – [**Remain Off**], [Turn On], or [Last State]

Use this field to determine how the system responds after an AC power loss, but this feature only operates with an ATX type power supply.

 - * If [Remain Off] is selected, the power is held off until the power button is pressed.
 - * If [Turn On] is selected, the power is restored to the computer, as soon as, AC power is available.
 - * If [Last State] is selected, power is restored to the previous power state before the power loss actually occurred.

NOTE

This feature only operates with an ATX type power supply. The term *AC power loss* used in this context refers to the loss of the standby voltage on the 5V_SB pins and is continuously monitored after the system is turned off. If the standby voltage is not detected after 30 seconds, then it is considered an AC power loss condition. If the standby voltage remains stable for 30 seconds, then it is assumed that the system was switched off properly.

If you use an inexpensive ATX power supply, you may experience a short AC power sag, where the system turns off but does not switch back on. This can occur even when the PS_ON# signal is asserted correctly by the module. In this case, the internal circuitry of the ATX power supply has become confused. Usually another AC power off/on cycle is necessary to recover from this situation.

The XTX 820 does not require a CMOS battery to support the *Power Loss Control* feature.

BIOS Security Setup Screen

BIOS Setup Utility					
Main	Advanced	Boot	Security	Power	Exit
Security Settings					Install or change the password
Supervisor Password: Not installed User Password: Not installed					
Change Supervisor Password Change User Password					
Boot Sector Virus Protection [Disabled]					
Hard Disk Security					Select Screen Select Item Enter Change F1 General Help F10 Save and Exit ESC Exit
▶ Hard Disk Security User Passwords					
▶ Hard Disk Security Master Passwords					

V02.xx (C) Copyright 1985-2004, American Megatrends, Inc.

Figure 4-4. BIOS Security Setup Screen

Security Settings

- Supervisor Password – [Installed] or [**Not Installed**]

Indicates if a supervisor password has been set.

 - * If the password has been installed, Installed appears on screen.
 - * If no the password has be selected, then Not Installed appears on screen.
- User Password – [Installed] or [**Not Installed**]

Indicates if a user password has been set. If the password has been installed, Installed displays. If not, Not Installed displays.
- Change Supervisor Password
 - a. Select **Change Supervisor Password** from the Security Setup menu.
 - b. Press <Enter> to access the pop-up menu, *Enter New Password*:
 - c. Type the password and press <Enter> again.

The screen will not display the password as you type.
 - d. Retype the password when prompted by the pop-up menu and press <Enter> again.

If the password is not confirmed when you retype it, an error message will appear. The password is stored in NVRAM and you have successfully entered the password.

To clear Supervisor password: .

 - a. Press <Enter> to access the pop-up menu, *Enter New Password*:
 - b. Do not enter a password and press the <Enter> key, following the prompts.
 - c. Repeat this process until the old password is gone, which is indicated by *Not Installed*.

If the Supervisor Password field has changed to “Installed”, the following item appears on the screen.

- ◆ User Access Level – [No Access], [View Only], [Limited], or [**Full Access**]
- Change User Password
 - a. Select **Change User Password** from the Security Setup menu.
 - b. Press <Enter> to access the pop-up menu, *Enter New Password*:
 - c. Type the password and press <Enter> again.
The screen will not display the password as you type.
 - d. Retype the password when prompted by the pop-up menu and press <Enter> again.
If the password is not confirmed when you retype it, an error message will appear. The password is stored in NVRAM and you have successfully entered the password.
If the Change User Password field is “Installed”, a Pop-Up screen, titled “Clear User Password?” appears with these selections.
 - ◆ Clear User Password – [OK] or [Cancel]
 - ◆ Password Check – [Setup] or [**Always**]
- Boot Sector Virus Protection – [**Disabled**] or [Enabled]
This field displays a warning when any program (or virus) issues a Disk Format command or attempts to write to the boot sector of the hard disk drive.
 - * If [Disabled] is selected, there is no Boot Sector Virus Protection warning displayed for the hard disk drive. This allows you to install your OS without interruptions, but once installed, enable this field to protect the boot sector from virus attacks.

CAUTION To prevent boot sector virus attacks after installing your OS, enable this field. Using this field to disable Boot Sector Virus Protection allows you to install your OS without interruptions, but leaves your system open to boot virus attacks.

- * If [Enabled] is selected, a warning is displayed when any program (or virus) issues a Disk Format command or attempts to write to the boot sector of the hard disk drive. A warning display also appears if there is any attempt to format any cylinder, head, or sector of any hard disk drive.

The following display appears when a write is attempted to the boot sector.

```
Boot Sector Write!
Possible VIRUS: Continue (Y/N)?
```

You may have to type N several times to prevent the boot sector write.

The following appears after any attempt to format any cylinder, head, or sector of any hard disk drive via the BIOS INT 13 Hard disk drive.

```
Service:
Format!!!
Possible VIRUS: Continue (Y/N)?
```

Hard Disk Security

>Hard Disk Security User Password – [Configure Hard Disk User Password]

- * If there are no HDDs supporting these features, you will see "There are no supported Hard Disk".

>Hard Disk Security Master Password – [Configure Hard Disk Master Password]

BIOS Power Setup Screen

BIOS Setup Utility					
Main	Advanced	Boot	Security	Power	Exit
APM Configuration				Enable or Disable APM	
Power Management/APM [Enabled]					
Suspend Time Out				[Disabled]	
Video Power Down Mode				[Suspend]	
Hard Disk Power Down Mode				[Suspend]	
Keyboard & PS/2 Mouse				[Monitor]	
FDC/LPT/ COM Ports				[Monitor]	
Primary Master IDE				[Monitor]	
Primary Slave IDE				[Monitor]	
Secondary Master IDE				[Monitor]	
Secondary Slave IDE				[Monitor]	
Resume on Ring				[Disabled]	
Resume on PME#				[Disabled]	
Resume on RTC Alarm				[Disabled]	
Power Button Mode				[On/Off]	
				Select Screen Select Item + - Change field F1 General Help F10 Save and Exit ESC Exit	

V02.xx (C) Copyright 1985-2004, American Megatrends, Inc.

Figure 4-5. BIOS Power Setup Screen

APM Configuration

- Power Management/APM – [Disabled] or **[Enabled]**
 - ◆ Suspend Time Out – **[Disabled]**, [1 Min], [2 Min], [4 Min], [8 Min], [10 Min], [20 Min], [30 Min], [40 Min], [50 Min], or [60 Min]
 - * If [Disabled] is selected, the system is prevented from entering the suspend mode.
 - * If [1 to 60] is selected, the system enters suspend mode after being inactive for the specified number of minutes, such as, 1 minute, 2 minutes, 4 minutes, etc.
 - ◆ Video Power Down Mode – [Disabled], [Standby] or **[Suspend]**
 - * If [Disabled] is selected, the BIOS is prevented from initiating any power saving modes related to the video display or the monitor.
 - * If [Standby] is selected, the monitor is placed into standby mode after the specified period of display inactivity has expired. The monitor screen appears blacked out, but the monitor remains powered in a low state.
 - * If [Suspend] is selected, the monitor is placed into a suspended mode after the specified period of display inactivity has expired. The monitor screen appears blacked out, but the monitor remains powered in a low state.
 - ◆ Hard Disk Power Down Mode – [Disabled], [Standby] or **[Suspend]**
 - * If [Disabled] is selected, the hard disk drive (HDD) is prevented from going into a power down mode.
 - * If [Standby] is selected, the hard disk drive (HDD) is stopped from spinning during this standby mode.
 - * If [Suspend] is selected, the power to the hard disk drive (HDD) is removed during this system suspend state.

- ◆ Keyboard & PS/2 Mouse Monitoring – [Ignore] or [**Monitor**]
- ◆ FDC/LPT/COM Ports Monitoring – [Ignore] or [**Monitor**]
- ◆ Primary Master IDE Monitoring – [Ignore] or [**Monitor**]
- ◆ Primary Slave IDE Monitoring – [Ignore] or [**Monitor**]
- ◆ Secondary Master IDE Monitoring – [Ignore] or [**Monitor**]
- ◆ Secondary Slave IDE Monitoring – [Ignore] or [**Monitor**]
- Resume On Ring – [**Disabled**] or [Enabled]
- Resume On PME# – [**Disabled**] or [Enabled]

This field sets the conditions for a PME# (PCI Management Event) used with ACPI power states.

- ◆ Resume on RTC Alarm – [**Disabled**] or [Enabled]
 - * If [Enabled] is selected the following options appear.
 - RTC Alarm Date (Day) – [**Every Day**], [01], [02], [03], [04], [05], [06], [07], [08], [09], [10], [11], [12], [13], [14], [15], [16], [17], [18], [19], [20], [21], [22], [23], [24], [25], [26], [27], [28], [29], [30], or [31]
 - System Time – [**12:30:30**]
- ◆ Power Button Mode – [**On/Off**] or [Suspend]

This field sets the function of the power button during On/Off power cycling or suspend/wake transitions.

BIOS Exit Setup Screen

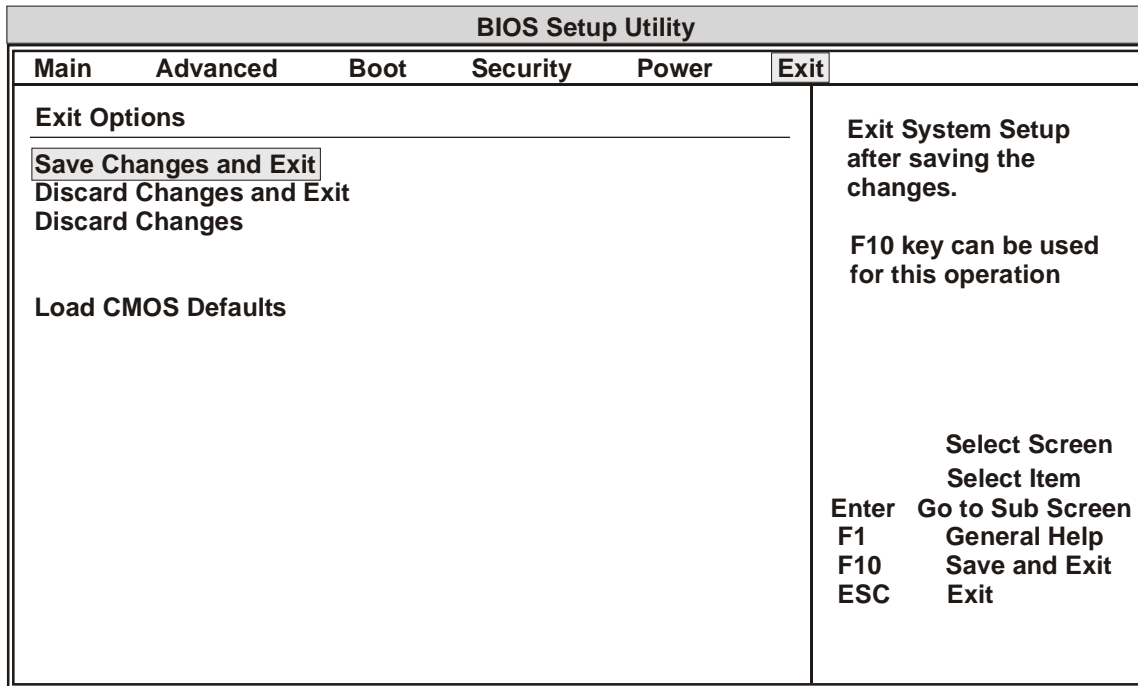

V02.xx (C) Copyright 1985-2004, American Megatrends, Inc.

Figure 4-6. BIOS Exit Setup Screen

Exit Options

- Save Changes and Exit

This selection allows you to leave Setup, saving your changes, and rebooting the system so the new BIOS Setup configuration parameters can take effect.

- Select **Save Changes and Exit** from the Exit Options menu and press *<Enter>*.

The following text appears on screen:

```
Save Configuration Changes and Exit Now?
```

```
[Ok][Cancel]
```

- Select *Ok* to save changes and exit.

The *< F10 >* key can also be used for this operation.

- Discard Changes and Exit

This selection allows you to quit Setup without making any permanent changes to the BIOS Setup system configuration.

- Select **Discard Changes and Exit** from the Exit Options menu and press *<Enter>*.

The following text appears on screen:

```
Discard Changes and Exit Setup Now?
```

```
[Ok][Cancel]
```

- Select *Ok* to discard changes and exit.

The *< ESC >* key can also be used for this operation.

- Discard Changes

This selection allows you to discard any changes made to BIOS Setup without leaving BIOS Setup.

- Select **Discard Changes** from the Exit menu and press *<Enter>*.

The following text appears on screen:

```
Discard Changes?
```

```
[Ok][Cancel]
```

- Select *Ok* to discard changes.

The *<F7>* key can also be used for this operation.

Loading Defaults

- Load CMOS Defaults

This selection automatically sets all BIOS Setup options to a complete set of default CMOS settings determined by the factory.

- Select **Load CMOS Defaults** from the Exit menu and press *<Enter>*.

The following text appears on screen:

```
Load CMOS Defaults?
```

```
[Ok][Cancel]
```

- Select *Ok* to load CMOS defaults.

The *<F9>* key can also be used for this operation.

Ampro Computers, Inc. provides a number of methods for contacting Technical Support listed in the Table A-1 below. Requests for support through the Virtual Technician are given the highest priority, and usually will be addressed within one working day.

- Ampro Virtual Technician – This is a comprehensive support center designed to meet all your technical needs. This service is free and available 24 hours a day through the Ampro web site at <http://ampro.custhelp.com>. This includes a searchable database of Frequently Asked Questions, which will help you with the common information requested by most customers. This is a good source of information to look at first for your technical solutions. However, you must register online before you can log in to access this service.
- Personal Assistance – You may also request personal assistance by going to the "Ask a Question" area in the Virtual Technician. Requests can be submitted 24 hours a day, 7 days a week. You will receive immediate confirmation that your request has been entered. Once you have submitted your request, you must log in to go to the "My Stuff" area where you can check status, update your request, and access other features.
- Embedded Design Resource Center – This service is also free and available 24 hours a day at the Ampro web site at <http://www.ampro.com>. However, you must be register online before you can log in to access this service.

The Embedded Design Resource Center was created as a resource for embedded system developers to share Ampro's knowledge, insight, and expertise gained from years of experience. This page contains links to White Papers, Specifications, and additional technical information.

Table A-1. Technical Support Contact Information

Method	Contact Information
Virtual Technician	http://ampro.custhelp.com
Web Site	http://www.ampro.com
Standard Mail	Ampro Computers, Incorporated 5215 Hellyer Avenue San Jose, CA 95138-1007, USA

The XTX 820 COM (Computer-On-Module) provides the LAN Boot feature, which can be enabled or disabled in the XTX 820 BIOS Setup Utility. The balance of this appendix describes the LAN Boot feature and briefly describes how to use the LAN Boot feature.

Introduction

LAN Boot is supported by the single Ethernet port on the XTX 820 baseboard, and is based on the Preboot eXecution Environment (PXE), an open industry standard. PXE (pronounced "pixie") was designed by Intel, along with other hardware and software vendors, as part of the Wired for Management (WfM) specification to improve management of desktop systems. This technology can also be applied to the embedded system market place. PXE turns the XTX 820 Ethernet port into boot device when connected over a network (LAN).

PXE boots the XTX 820 from the network (LAN) by transferring a "boot image file" from a server. This image file is typically the operating system for the XTX 820, or a pre-OS agent that can perform management tasks prior to loading the image file (OS). A management task could include scanning the hard drive for viruses before loading the image file.

PXE is not operating system-specific, so the image file can load any OS. The most common application of PXE (LAN Boot) is installing an OS on a brand new device (hard disk drive) that has no operating system, (or reinstalling it when the operating system has failed or critical files have been corrupted).

Using PXE prevents the user from having to manually install all of the required software on the storage media device, (typically a hard disk drive) including the OS, which might include a stack of installation CD-ROMs. Installing from the network is as simple as connecting the XTX 820 and its baseboard to the network and powering it on. The server can be set up to detect new devices and install software automatically, thereby greatly simplifying the management of small to large numbers of systems attached to a network.

If the hard disk drive should crash, the network can be set up to do a hardware diagnostic check, and once a software-related problem is detected, the server can re-install the defective software, or all the XTX 820 software from the server. Booting from the network also helps insure a "clean" boot, with no boot-time viruses or user-modified files. The boot files are stored on the PXE server, protected from infection and user-modification.

To effectively make use of the Ampro supplied feature (LAN Boot), the XTX 820 requires a PXE boot agent for set up and PXE components on the server side as well. These include a PXE server and TFTP (Trivial File Transfer Protocol) server. The PXE server is designed to work in conjunction with a Dynamic Host Configuration Protocol (DHCP) server. The PXE server can be shared with DHCP server or installed on a different server. This makes it possible to add PXE to an existing network without affecting the existing DHCP server or configuration. Refer to the web sites listed here for sources of PXE boot agents and server components. For a more detailed technical description of how PXE works go to, <http://www.pxe.ca>. For more detailed information concerning pre-OS agents, go to: <http://www.pre-OS.com>.

Ampro provides an Intel® PXE boot agent integrated into the XTX 820 BIOS, but does not provide the PXE server or its components. You will need to provide your own PXE server components on a compatible PXE server, before making full use of the LAN Boot feature. After you change the BIOS settings to enable the LAN Boot feature and move it to the top of the boot order, you will need to exit BIOS Setup, saving your settings, and reboot the system before your changes take effect. Refer to the next topic, *Accessing the LAN (PXE) Boot Feature*, for setup information.

Accessing the LAN (PXE) Boot Feature

This section describes how to access Intel's PXE Boot agent integrated into the XTX 820 BIOS Setup Utility. This version of Intel's PXE Boot agent only supports one protocol, the Wired for Management (WfM) 2.0 specification for Preboot eXecution Environment (PXE).

If there is an Ethernet connection to the baseboard and the *PXE Boot to LAN* option is set to Enabled in BIOS Setup, the BIOS auto detects the Ethernet connection and searches for the PXE server and boot image as soon as you boot the system. However, the LAN Boot feature should be moved to the top of the boot order, so the BIOS will detect the Ethernet connection as first boot device.

To use the LAN Boot feature, refer to this procedure:

1. Connect your LAN connection to the XTX baseboard so the BIOS will detect the Ethernet connection.
2. Power on the XTX 820 and its baseboard to access the BIOS Setup Utility.
3. Press the *DEL* key early in the boot process to ensure access to the BIOS Setup Utility.
4. Go to the **Boot** menu and scroll down to *PXE Boot to LAN [Disabled]* under Boot Settings Configuration and set it to *[Enabled]*.
5. Scroll up to the Boot Device Priority and select the 1st Boot Device by pressing the <Enter> key.

You should see a list of the available options. The Ethernet connection must be moved to the top of the boot order to ensure it is the first boot device selected. Depending on the Boot Priority Selection setting, the Ethernet connection will be listed as [Onboard LAN] for Type Base, and [Network: IBA xx.xx.xx] for Device Base.

6. Scroll through the available selections for the 1st Boot Device and select [Onboard LAN] or [Network: IBA xx.xx.x] depending on the settings.
7. Press **F10** to Save and Exit the BIOS Setup.

This should reboot the system and you should see, however briefly, messages similar to the ones shown below, indicating the PXE Boot Agent is being initialized. This message will appear if *PXE Boot to LAN* has been Enabled.

```

Initializing Intel (R) Boot Agent FE v4.x.xx
PXE v2.0 Build 0xx (WfM 2.0),

```

Once the PXE Boot Agent has been initialized, it will make two attempts to find and load the boot image using a DHCP server (PXE Server). If it does not locate the PXE Server, an error message will appear as it looks for another boot device. Messages similar to the ones listed below may appear, however briefly, on screen.

```

Intel (R) Boot Agent Version xx.x.xx
Copyright © 1997-2001, Intel Corporation

```

```

Intel Base Code PXE-2.1 (build 083)
Copyright © 1997-2001, Intel Corporation

```

```

Client Mac Addr: xx xx xx xx xx xx
DHCP ...../ (looking for PXE server and boot filename)

```

(If errors occur, you might see some of the following messages)

```

PXE-E53: No boot filename received (no boot filename found)

```

Or

```

PXE-E61: Media test failure, check cable (no cable connection)

```

```

PXE-M0F: Exiting Intel Boot Agent

```

Alternate Method of Selecting LAN Boot.

The boot process reveals an alternate method of accessing the Network (LAN Boot) if your monitor powers up quickly enough. You will see a text line similar to the one shown below immediately after the *Press to enter BIOS Setup* message displayed on screen.

Press F12 if you want to boot from the Network

If *PXE Boot to LAN* has been set to *[Enabled]*, then you can use this feature to skip the other boot devices and go immediately to the Network (PXE Boot Agent) to boot the system.

1. If you have not set *PXE Boot to LAN* to *[Enabled]*, do so before continuing.
2. Press **F10** to Save and Exit the BIOS Setup.

This should reboot the system and you should see, however briefly, the PXE initialization message shown earlier.

3. Press **F12** to boot the system using the LAN boot (PXE) feature.

This selects the network (Onboard LAN or Network: IDA ...) ahead of the other boot devices for the current boot and you will see the text line change to the following message.

Network selected as first boot device for the current boot

Once this text message appears on screen, you should see the system going through the cycle of booting from the Network shown earlier.

Appendix C

Connector Part Numbers

The connector listed in Table C-1 is used for the onboard SDVO (Serial Digital Video Output) connector, located on the bottom of the board. The manufacturer's part number can be used to determine the mating connector when making your own cables.

Table C-1. Connector and Manufacture's Part Numbers

Connector	Pin Number/Pin Spacing/ Orientation	Manufacturer	Manufacturer's PN
J6 – SDVO	40-pin, 0.5 mm, Right Angle	Hirose	FH12-40S-0.5SH (55)

The following list provides the Manufacturer abbreviation used in this table and the web site where you can locate the required mating connector information.

Hirose = Hirose Electric Co. Ltd @

<http://www.hirose-connectors.com>

Index

ACPI	
Advanced Configuration and Power Interface.....	59
allows reduced power consumption	59
Ampro Products	
CoreModule™ Family	3
ETX 700	3
ETX 802	3
LittleBoard™ Family.....	3
MightyBoard™ Family.....	3
MiniModule™ Family	4
ReadyBoard™ Family	4
XTX 800.....	3
BIOS Setup Utility	
32-bit data transfer.....	72
accessing BIOS Setup in	
console redirection mode.....	62
remote access mode.....	62
serial console mode	62
VGA Display.....	61
ACPI	
Feature settings.....	64
Power Button setting	87
Power Management settings.....	87
Resume on PME# setting	87
Resume on Ring setting.....	87
Resume on RTC Alarm settings	87
additional parallel & port settings	69
AddOn ROM Display mode setting	82
ATA 80-pin cable settings.....	76
ATE/IDE Configuration	70
Automatic Boot List Retry settings	82
Azalia (High Definition Audio) setting	66
block mode IDE drive transfers.....	70
boot device priority.....	81
Boot Sector Virus protection.....	85
Boot Setting configuration	81, 82
can't see entry prompt	61
Celeron CPU settings	67
clearing supervisor password.....	84
clearing user password	85
Clock (video) configuration	69
CMOS Exit settings.....	88
console redirection settings	78
CPU and module information.....	63
CPU temperature trip settings.....	64
CPU values	63
DMA mode.....	71
Exit settings	88
Exit short cut keys	88
flat panel (LVDS) settings.....	66
floppy configuration	68
Graphic configuration settings.....	66
Halt On error setting	83
Hard Disk Power Down Mode settings	86
Hard Disk Write Protect setting	75
Hardware Health configuration.....	79
High Definition Audio (Azalia - Intel).....	66, 68
I/O Hub settings	67
IDE Detect Time Out settings	75
IDE/SATA channel settings.....	70
Infrared (IrDA) settings	68
installing operating system without errors	85
Interrupt 19 Capture setting	83
Keyboard/Mouse settings.....	78
LAN Boot (PXE Enable) settings	83
Legacy USB support settings.....	76
Lid switch (GPE1) settings	64
Loading default settings.....	89
LVDS clock settings	69
memory settings	67
Menu list	62
onboard Audio controller settings.....	68
onboard Ethernet setting	68
onboard Floppy setting.....	68
OS power savings (C3)	67
optimal/fail-safe values	63
Parallel port settings.....	68
PCI	
Configuration settings.....	65, 67
Express settings.....	68
Interrupt routing	65
IRQ settings	65
Latency timer setting.....	65
Pentium CPU settings	67
PIO mode	71
Plug and Play enable	65
Power Button setting	87
power loss feature defined	83
Power Management settings	86, 87
Primary IDE Master settings.....	70
Primary IDE Slave settings	72
PXE Boot to LAN setting	83
Quick Boot settings.....	82
Quiet Boot settings.....	82
Remote Access configuration	78
remote access terminal settings.....	79
S.M.A.R.T. for HDD.....	72
SDVO Port settings.....	66
Secondary IDE Master settings.....	72
Security settings	84
Serial console settings.....	78, 79
serial port baud rate.....	78
serial port settings	68, 79
setting Boot Sector Virus protection	85
Sleep button (GPE2) settings	65
splash screen (OEM boot logo).....	9, 82
Spread Spectrum Clocking (SSC).....	40, 69
supervisor password, setting	84
supported boot device list.....	81

- Suspend Time Out settings 86
- time and date settings 63
- TV Out settings..... 66
- USB
 - Beep message setting 77
 - Configuration settings..... 76
 - Mass storage device settings..... 77
 - Memory stick setting 77
- User password 84
- using BIOS Setup in remote access mode 62
- Video Power Down Mode settings 86
- watchdog timer (WDT) settings 57, 64, 79
- boot device
 - CD-ROM 81
 - Ethernet..... 81
 - Floppy disk drive 81
 - Hard disk drive 81
 - LAN Boot 93
- CAUTION
 - CPU thermal requirements 14
 - boot sector virus attacks 85
 - legacy USB devices not recognized..... 76
 - matching USB mass storage
 - type and emulation..... 77
- CD-ROM
 - XTX 820 Doc & SW 2
- Celeron CPU
 - power requirements 14
- chip specifications
 - web sites 2
- connectors
 - connector list 12
 - SDVO part number 97
- Console redirection
 - accessing BIOS..... 62
 - serial port settings..... 62
 - serial terminal 56
 - serial terminal emulation 56
 - supported feature 56
 - terminal emulation software 56
 - terminal settings..... 79
 - See also* serial console
 - See also* remote access
- CPUs
 - heatspreader 14
 - power requirements 14
 - require heatsink 56
 - supported features..... 16
- dimensions..... 13
- Documentation and Support
 - Software (Doc & SW) CD-ROM 2
- EIDE/Parallel ATA drive settings 70
- environmental specifications 14
- Infrared (IrDA)
 - interface 38
 - settings..... 68
 - supported features..... 38
 - web site information 38
- Intel Celeron M CPUs
 - features 7, 16
 - supported processors 6, 16
- Intel Pentium M CPU
 - features 7, 16
 - supported processor..... 6, 16
- LAN Boot
 - BIOS settings 83
 - DHCP (Dynamic Host Configuration Protocol) server 93
 - features 93
 - OS dependent 93
 - Pxe Boot to LAN..... 83
 - TFTP (Trivial File Transfer Protocol) server 93
- Lithium Battery
 - RTC..... 50
- major integrated circuits (chip)
 - chip descriptions..... 11
 - list of 11
 - specifications..... 2
 - web sites 2
- memory
 - flash memory 16
 - memory map 17
 - requirements 16
 - settings 67
- NOTES
 - BIOS Setup default settings 63
 - can't see boot prompts 61
 - faster ATA hard drives require
 - 80-pin cables 76
 - installing operating system without errors 85
 - power loss defined..... 83
- PCI Bus
 - interface..... 19
 - up to 33 MHz 19
- Pentium CPU
 - features 16
 - power requirements 14
- power
 - low voltage reset 58
 - requirements 14
- Preboot Execution Environment (PXE) 93
- pre-OS agent 93
- processor requirements
 - heatsink required 14, 16, 56
 - heatspreader 14, 16
- PXE Boot
 - Boot agent 93
 - Preboot Execution Environment (PXE) 94
 - PXE Boot to LAN settings 83
 - third party supplier 94
 - Wired for Management (WfM) 94
- PXE server components 93
- QuickStart Kit
 - contents 2
 - XTX 820 2

- Real Time Clock (RTC) 50
- reference material
 - ETX specifications 1
 - infrared (IrDA) 38
 - PCI 2.1 specifications 1
 - specifications 1
 - web sites 1
 - XTX specifications 1
- Remote access
 - accessing BIOS 62
 - serial port settings 62
 - serial terminal 56
 - serial terminal emulation 56
 - supported feature 56
 - terminal emulation software 56
 - terminal settings 79
 - See also* console redirection
 - See also* serial console
- SDVO connector
 - part number 97
 - pin-out listing 55
- Serial ATA drive settings 70
- Serial Communications Software 56
- serial console
 - accessing BIOS 62
 - serial port settings 62
 - serial terminal 56
 - serial terminal emulation 56
 - supported feature 56
 - terminal emulation software 56
 - terminal settings 79
 - See also* console redirection
 - See also* remote access
- serial terminal
 - ANSI-compatible 56
 - terminal emulation 56
- sleep states (ACPI)
 - operating system (OS) power management 59
 - reduced power consumption 59
 - supported feature 58
- SMBus
 - supported features 50
- specifications
 - ETX reference material 1
 - Infrared (IrDA) 38
 - PCI 2.1 reference material 1
 - reference material 1
 - XTX reference material 1
- splash screen
 - customized image 82
 - OEM boot logo 82
- supported features
 - 200-pin DDR2 SODIMM socket 7, 16
 - 512kB flash memory 16
 - AC'97 audio interface 8, 24
 - battery-free boot 50
 - chip descriptions 11
 - console redirection 9, 56, 79
 - CRT (VGA) interface 39
 - customizable splash screen 9, 82
 - current requirements
 - (measurement conditions) 14
 - Ethernet interface (1) 8, 48
 - ExpressCards 29
 - extended system management interface 31
 - external (Lithium) Battery 9, 50
 - flat panel configurations 66
 - floppy disk drive (1) 7, 35
 - HDA (High Definition Audio,
 - Intel - Azalia) 31, 66
 - High Definition Audio (Azalia - Intel) 31, 66
 - I/O address map 18
 - IDE channels (3) 7, 46
 - Infrared (IrDA) interface 8, 38, 68
 - Intel Celeron M CPUs 7, 16
 - Intel Pentium M CPUs 7, 16
 - Intel Speedstep 56, 67
 - IRQ assignments 16
 - LAN Boot (PXE) 93
 - LAN Boot settings 83, 94
 - LPC (Low Pin Count) bus 7, 31
 - LVDS flat panel 8, 40
 - memory map 17
 - memory (PC2 3200 DDR2 400) 7, 16
 - OEM Logo (splash screen) 9, 82
 - PCI bus 7, 19
 - PCI Express 29
 - Power control & management signals 49
 - PS/2 keyboard interface 8, 38
 - PS/2 mouse interface 8, 38
 - Real Time Clock (RTC) 9, 50
 - Remote access 9, 56, 79
 - SDVO connector (part number) 55, 97
 - Serial ATA (SATA) 30, 70
 - serial console 9, 56, 79
 - serial interrupt request not used if 24
 - serial ports, buffered TTL (2) 7, 37
 - shared floppy/parallel port 7, 8, 35, 36
 - sleep states (ACPI) 58
 - SMBus interface 9, 50
 - SODIMM DDR2 memory 7, 16
 - speaker interface 49
 - splash screen (OEM boot logo) 9, 82
 - thermal monitoring 14, 57, 64
 - thermal sensor 57
 - TV Out (Component and S-Video) 42
 - TV Out settings 66
 - USB ports (6) 8, 24, 30
 - video interface 39
 - watchdog timer(WDT) 9, 79
- Technical Support
 - contact information 91
 - Embedded Design Resource Center 91
 - Virtual Technician 91
- terminal emulation software
 - console redirection 56

Index

serial console	56	ExpressCards	29
remote access	56	features	7
thermal sensor		floppy disk drive (1)	35
supported feature	57	HDA (High Definition	
typical design flow	6	Audio Intel - Azalia)	31
wake up activity		I/O address map	18
keyboard activity	59	IDE channels (3)	46
mouse activity	59	Infrared (IrDA) interface	38, 39
power-on switch	59	Intel Celeron M CPU	6, 16
sleep states (ACPI)	59	Intel Pentium M CPUs	6, 16
wake on LAN	59	IRQ assignments	16
wake on Ring	59	LAN Boot	93
watchdog timer (WDT)		low voltage reset	58
30 sec to 30 min	57	LPC (Low Pin Count) bus	31
functions	57	LVDS (flat panel) interface	40
settings	57, 64, 79	major integrated circuits (chips)	11
System Utility	57	memory	16
WDT	57	memory map	17
web sites		mounting dimensions	13
audio chip specifications	2	parallel port connection	36
chip specifications	2	PCI bus interface	19
Ethernet chip specifications	2	PCI Express	29
Infrared (IrDA) specifications	38	power control & management signals	49
LAN boot information	93	power requirements	14
major integrated circuits (chip) specifications	2	product description	6
PXE specifications	93	PS/2 keyboard	38
reference material	1	PS/2 mouse	38
weight	13	QuickStart Kit	2
Wired for Management (WfM) specification	93	Real Time Clock (RTC)	50
XTX 820		Serial ATA (SATA)	30, 70
512 kB flash memory	16	serial console	56
AC'97 audio	24	serial interrupt request not used if	24
ACPI features	59	serial ports (2)	37
BIOS Setup Utility	61	shared parallel/floppy	36
block diagram	10	SMBus interface	50
board thickness	13	speaker interface	49
can't see BIOS entry prompt	61	splash screen (OEM boot logo)	82
Computer-On-Module concept	5	thermal monitoring	57
connectors	12	thermal sensor	57
console redirection	56	TV Out	42
CRT (VGA) support	39	USB ports (6)	24, 30
current measurement conditions	14	wake up activity	59
dimensions	13	watchdog timer (WDT)	57, 79
Documentation and Support		weight	13
Software (Doc & SW) CD-ROM	2	<i>see also supported features</i>	
Ethernet interface (1)	48		

